

English

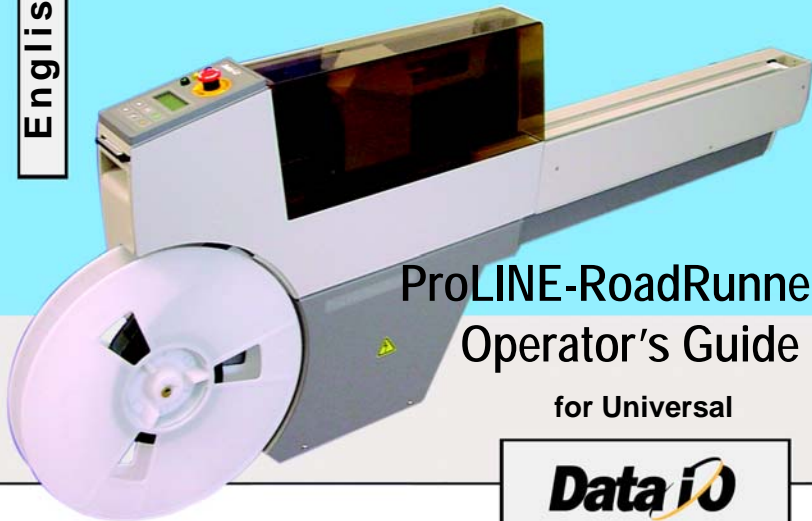

ProLINE-RoadRunner™ Operator's Guide

for Universal



PN 096-0234-002

CONTENTS

Overview



Installation



Job Setup



Operation



Maintenance



Troubleshooting



Data I/O has made a conscientious effort to ensure that the information in this document is accurate and complete. Data I/O assumes no liability for errors, or for any incidental, consequential, indirect, or special damages, including, without limitation, loss of use, loss or alteration of data, delays, or lost profits or savings, arising from the use of this document or the product which it accompanies.

No part of this document may be reproduced or transmitted in any form or by any means, electronic or mechanical, for any purpose, without written permission from Data I/O.

Data I/O is a registered trademark of Data I/O Corporation. TaskLink is a trademark of Data I/O Corporation. ProLINE-RoadRunner is a trademark of Data I/O Corporation.

Data I/O Corporation acknowledges the trademarks of other organizations for their respective products or services mentioned in this document.

© 2005 Data I/O Corporation
All rights reserved



Chapter 1

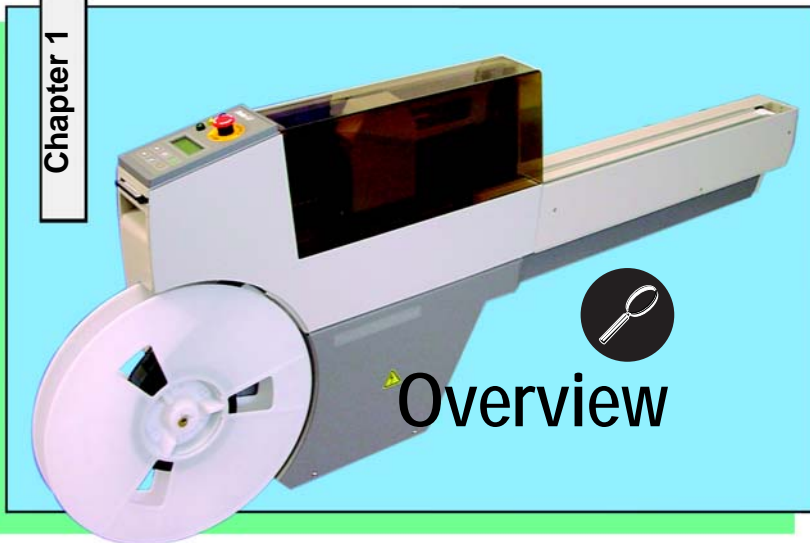

ProLINE-RoadRunner for Universal.....	2
Jobs and Statistics.....	3
External View.....	4
Internal Components.....	5
Control Panel Lights.....	6
Control Panel Buttons.....	7
Operator Menus.....	8
Supervisor Menus.....	9
Warnings and Cautions.....	12
Technical Support.....	53





The ProLINE-RoadRunner for Universal

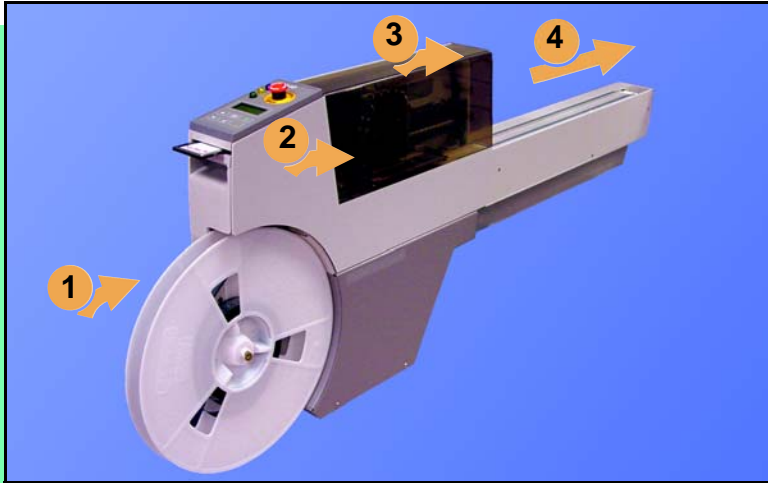

Data I/O is proud to introduce a revolutionary new inline solution for high-volume programming of electronic products.

The ProLINE-RoadRunner:

1. Takes programmable devices from a reel...
2. Places them in sockets and programs them with your data...
3. Places them on a conveyor belt...
4. Delivers them to the pick point of your assembly machine. ■



Jobs and Statistics

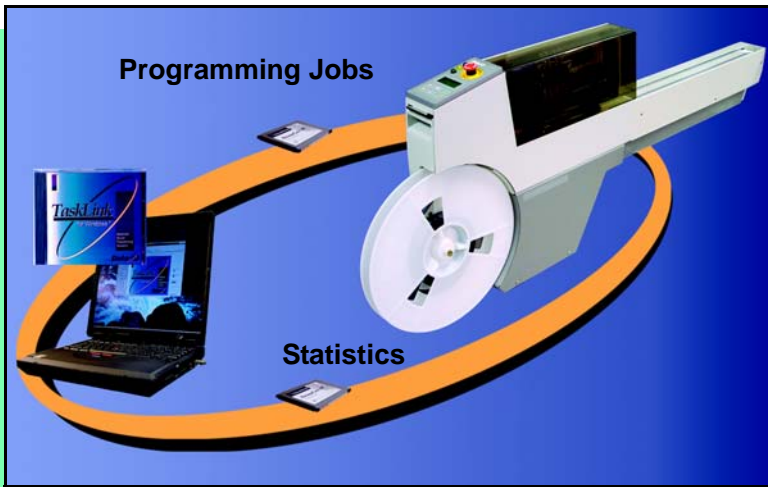

TaskLink™ for Windows® is required to process devices on the ProLINE-RoadRunner.

TaskLink allows you to create and manage a job database and it analyzes job statistics.

PCMCIA cards are used to transfer jobs and statistics between TaskLink and RoadRunner.

For more information on TaskLink, see the TaskLink Help Menu. ■





External View

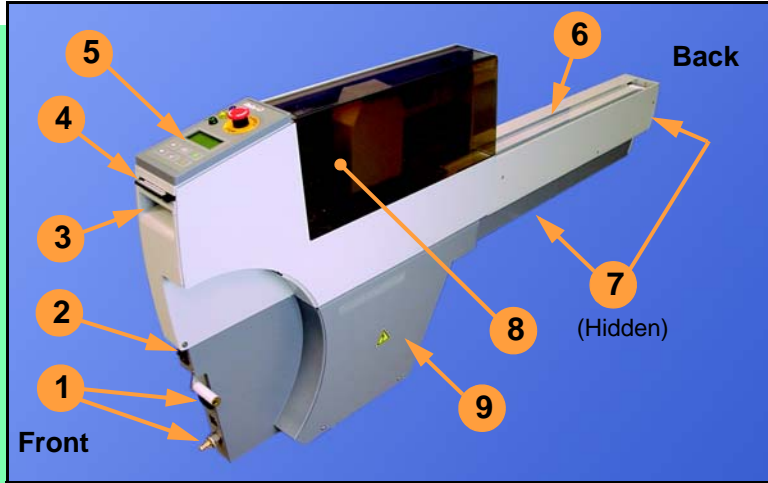

1. Power and Air Connections
2. Power Switch
3. Handhold for lifting
4. PCMCIA Card Slot and Eject button
5. Control Panel
6. Conveyor Belt with Dust Cover
7. Mechanical Interface to the Feeder Bank
8. Robotics Cover
9. Electronics Enclosure ■



Internal Components

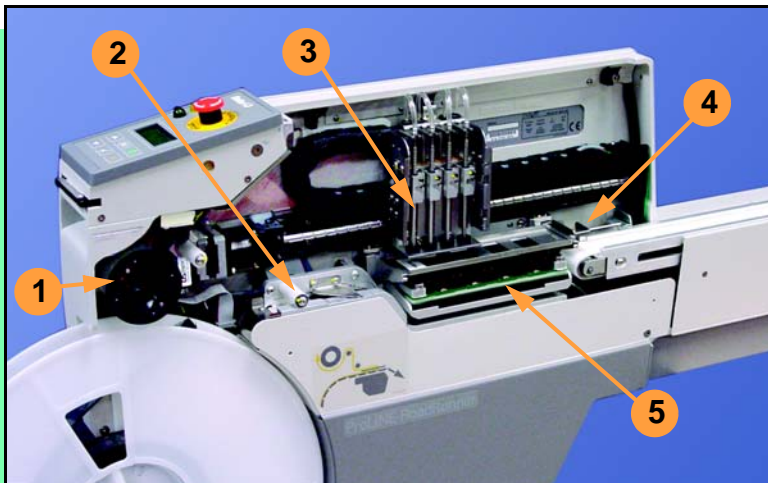

1. Cover Tape Take-Up Reel
2. Tape-In Module
3. PNP Probes, Precisor, and Cover
4. Reject Bin
5. Socket Adapter, Actuator Plate, and Programmer ■





Control Panel Lights

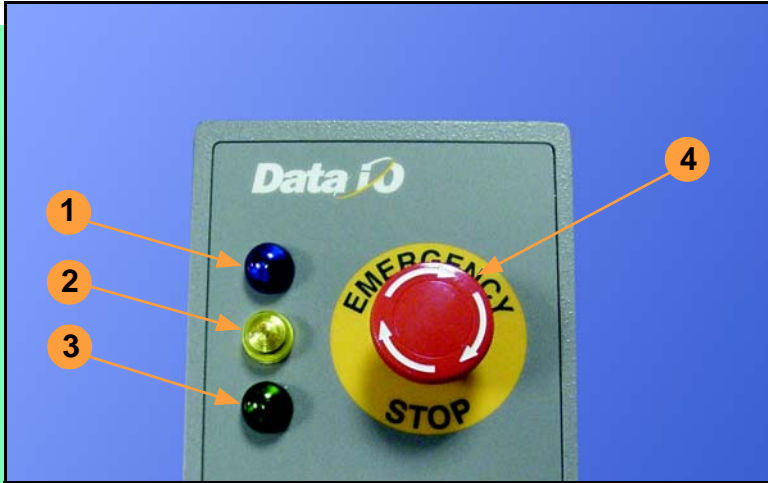

1. **Blue** - Stop Indicator.
User intervention is required, or the unit is paused.
(Do not remove PCMCIA card unless blue lamp is lit.)
2. **Yellow** - Caution Indicator.
Correct a problem or the machine will stop.
3. **Green** - Run Indicator.
Lit: A job is running.
Blinking: Programmed devices are not yet at the SMT pick point.
4. **Emergency Stop** - Press to stop the robot motors in an emergency. To resume motion, twist the button and press Start. ■



Control Panel Buttons

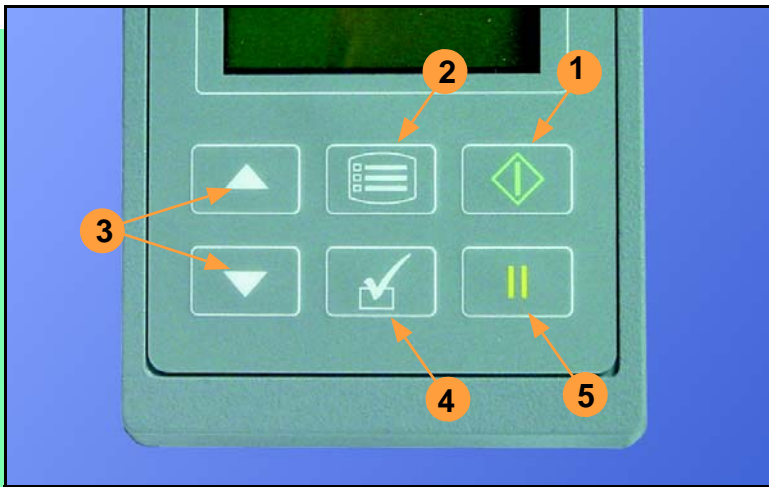

1. Start - start or resume the chosen job.
2. Menu - exit to the previous menu, —or show the next message (deleting the current one), —or deselect an item.
3. Up and Down Arrows - move through menu items.
4. Select - select menu items.
5. Pause - interrupt the job without cancelling it. ■





Operator Menus

Main Menu
Job
Advance Pocket
Align Pocket
Purge
Socket

- Light gray shaded fields cannot be changed.
- For Advance Pocket, Align Pocket, and Purge, see Chapter 3 in the Owner's Manual.

Job	
View	Job Name
	Device: E28F320
	Checksum: 3FC00000
	Mfg: INTEL
	Adapter: PA-G021
	Prec: 621-0086-005
	Act: 644-0016-001
Results	Passed: 992
	Failed: 4
	System Yld: 98.7
	Prgrmr Yld: 99.6
	Handler Yld: 99.5
	Parts/Hour: 255
	MCBI: 201
	Skt 1 Yld: 99.9
	Skt 2 Yld: 100
	Skt 3 Yld: 100
	Skt 4 Yld: 100
	Skt Cycles: 249
End	

Socket	
Socket 1: Enabled	
Socket 2: Enabled	
Socket 3: Enabled	
Socket 4: Enabled	
Adapter Statistics	Reset Clean
	Clean Count
	Clean Alert: 3500
	No: 22113204
	Mfg: 09/23/02
	Actuations:1055
	Adptr. Life: 10000
	Insertions: 4220
	Pass: 4202
	Fail: 16
	Yld: 99.5
Socket 1	
	Insertions: 1055
	Pass: 1053
	Fail: 2
	Yield: 99.8
Socket 2 [same as 1]	
Socket 3 [same as 1]	
Socket 4 [same as 1]	

Operator Menus are visible on the RoadRunner control panel, and can be navigated by using the Up Arrow and Down Arrow buttons.

Pressing the Menu button displays the menu that is one level up. If you are at the main menu, pressing menu will have no effect. Job is the first item in the main menu.

NOTE: To change languages press Menu while pressing the Select button. Arrow Down to the desired language and press Menu twice.

Version 5.11.00 menus shown. ■



Supervisor Menus

Main Menu
Job
Advance Pocket
Align Pocket
Purge
Socket
Home
Operation*
System*
Robot Diagnostics^
Programmer Diags^
Event Log^

* Next page

^ Next two pages

- HOME sends the PNP Head to the Home position.
- Light gray shaded fields cannot be changed.

Job	
View	Job Name Device: E28F320 Checksum: 3FC00000 Mfg: INTEL Adapter: PA-G021 Prec: 621-0086-005 Act: 644-0016-001
Results	Passed: 992 Failed: 4 System Yld: 98.7 Prgrmr Yld: 99.6 Handler Yld: 99.5 Parts/Hour: 255 MCBI: 201 Skt 1 Yld: 99.9 Skt 2 Yld: 100 Skt 3 Yld: 100 Skt 4 Yld: 100 Skt Cycles: 249
End	
Select	▶ Job 1 ● Job 2 End of List

Socket	
Socket 1: Enabled	
Socket 2: Enabled	
Socket 3: Enabled	
Socket 4: Enabled	
Adapter Statistics	Reset Clean Count
	Clean Count
	Clean Alert: 3500
	No: 22113204
	Mfg: 09/23/02
	Actuations: 1055
	Adptr. Life: 10000
	Insertions: 4220
	Pass: 4202
	Fail: 16
	Yld: 99.5
	Socket 1
	Insertions: 1055
	Pass: 1053
	Fail: 2
	Yield: 99.8
	Socket 2 [Same as 1]
	Socket 3 [Same as 1]
	Socket 4 [Same as 1]

View the Supervisor Menus by inserting a PCMCIA card with supervisor authority. (The menus on this page and the next two pages are in addition to the Operator Menus.)

Supervisor (Administrator) authorization is set in TaskLink. For more information, refer to the TaskLink Help Menu.

Version 5.11.00 menus shown.

A (●) indicates the currently selected item.

A (▶) indicates the current cursor position.





Supervisor Menus, continued

Operation	
Job	Pick Retries: 2 Error Retries: 3 Pocket Pitch: 4 Pocket Advance: 3
Head	Velocity: 250 Accel: 700
Probes	Puff: 50 Pick: 200 Place: 100 Travel: 250
Teach	Tape: 40.0 Skt 1: -26.85 Reject: -166 Belt: -180 Restore Defaults

- Light gray shaded fields cannot be changed.

System	
Time	Hour: 4 Minute: 55 Month: 9 Day: 23 Year: 2002
Odometer	Hours: 469.92 Devices: 24742 Timekeeping: OFF Erase: 0.0s Blankcheck: 0.0s Program: 0.0s Verify: 0.0s
Update Software	
Network	Network Parm:Card Status: Enabled PGM: Fred'sRR2 IP: 139.138.16.215 Prog Port: 7596 SUB: 255.255.248 GTW: 139.138.16.1 SNS: 0.0.0.0

System	
Network (cont.)	SNS Port: 7500 HST: rr215.nt.data-io DOM: nt.data-io.com DNS: 139.138.16.105 DTS: 139.138.16.13 EAddr: 0010EC002211 Clear NetParms
Configuration	Firmware Version Ver 05.11.00.C Installed Boards Bkpln Brd Id: 2 Cntrl Brd Id: 1 Wvfrm Brd Id: 1 Adptr Brd Id: 3 Hardware Config HwCfgIds 1, 3, 4 Model: name (-uC)

Refer to the previous page for the main menu.



Supervisor Menus, continued

Robot Diags	
Robot:	Enabled
Run Mode:	Job/Dry Run
Belt	Move:Fwd/Bkw
	Pick Sensor: 0
	Speed: 400 ± 10
	Measure Device Adjust Device
Sensors	Tape Sprocket: 0
	Tape Broken: 0
	Reject Full: 0
	Reject Bin: 1
	Air: 1
	Interlock: 0
	E-Stop: 0
	+Overtravel: 0 Home: 1
Socket	State: Up
	Actuate: 0
	Act.Duration:150 ¹
Probe 1- 4	Position: Up
	Vacuum: Enabled
	Puff: Enabled
	Vac Sense: 1 Speed: 135 ± 5
Head Position	Head: 0

Programmer	Diags
Programr: Enabled	
Exercise Display	
Test Cycles: 3	
Test All: PASS	Programmer Diagnostic tests require a Diagnostic Adapter Board for all items below this line.
Bus Test: PASS	
Adtr ID Test: PASS	
LED Dvr Test: PASS	
G Node Test: PASS	
Vcc OC Test: PASS	
Vpp OC Test: PASS	
I2C Bus Test: PASS	
DAC Ref Test: PASS	
GSlew Test: PASS	
High RAM Test:	
Continuity Loop: 3	

Event Log	
View	
Clear	

- Light gray shaded fields cannot be changed.

Refer to the main Supervisor Menu (2 pages back) for orientation.

NOTE: Programmer Diags are only available with a Diagnostic Adapter Board.

¹ Actuation duration is set by the Socket Adapter.

For more information about menu commands, see Chapter 3 of the ProLINE-RoadRunner Owner's Manual. ■





Warnings and Cautions



Compressed Air

Point air hoses away from body. Always wear approved eye protection.



Loud Noise

Sound pressure levels may exceed 85db. Hearing protection is recommended for prolonged exposure at this level.



High Voltage

Turn power off before removing electronics cover.



Heavy Object

This equipment weighs approximately 15Kg (35 lbs). Do not drop. Mount only with approved hardware.



Moving Parts

Pinch warning. Keep hands away from moving parts.



Electrostatic Discharge

Electrostatic Discharge (ESD) may cause damage. Discharge static against a common ground.



Chapter 2

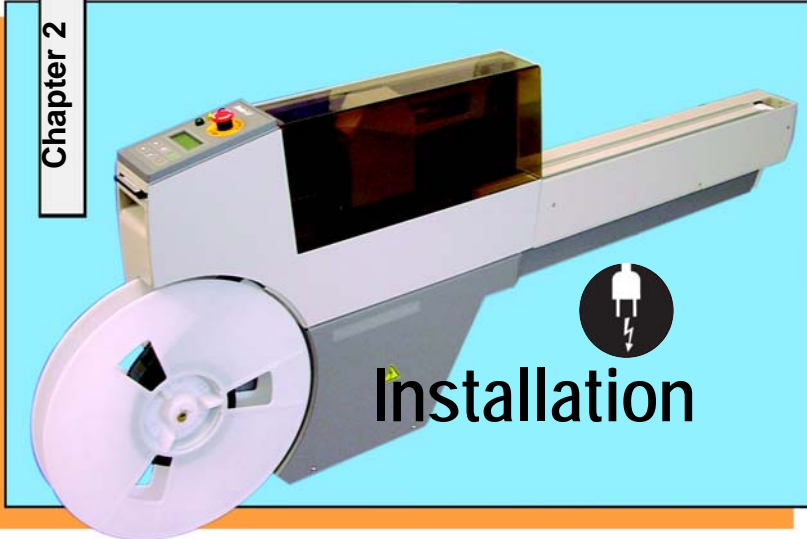

Installation

**Mounting on the
Assembly Machine..... 12**

Connecting Power and Air 16

Running the Self-Test 18





Mounting on the Assembly Machine

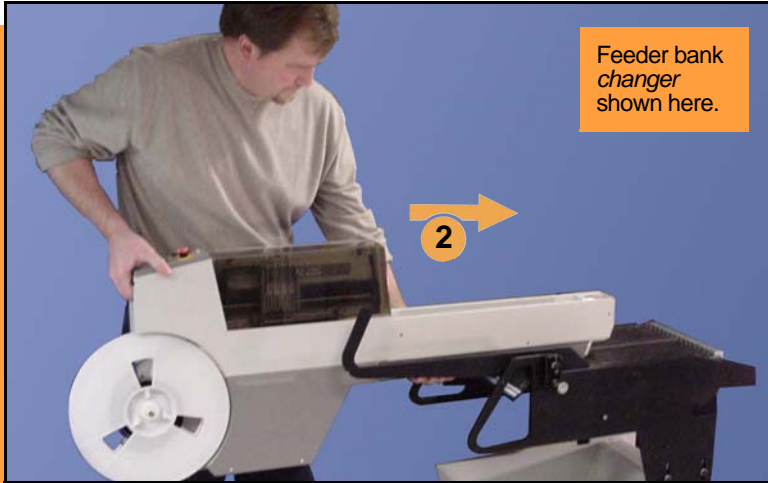

To mount RoadRunner onto a feeder bank:

1. While holding RoadRunner at a slight nose-down angle, let the nose rest on the bank. Ensure that the guide under the conveyor settles into a slot.
2. Level RoadRunner while continuing to support the weight, and slide it forward as far as it will go.



Warning:



Heavy. 17 kg (38 lb). Do not drop.
Mount only on approved units.

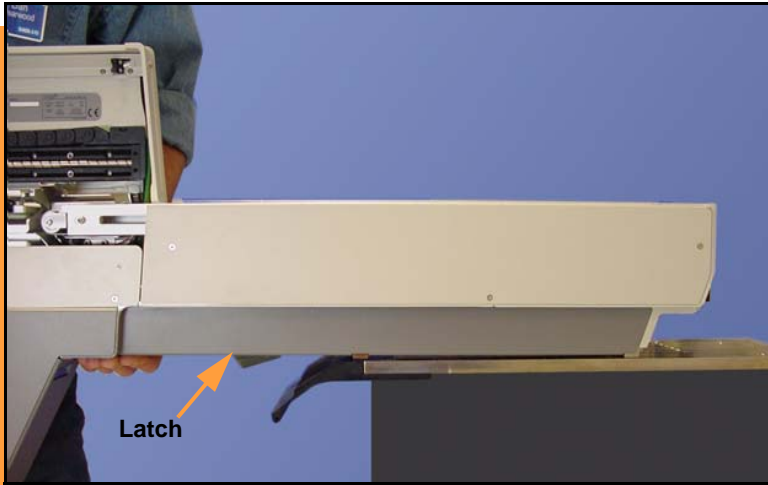

The communication path will connect automatically with spring pins.

3. Lower RoadRunner. Its own weight will cause it to latch to the feeder bank.

NOTE: RoadRunner may also be installed onto Feeder Carts.

To remove RoadRunner, turn it off, lift it up enough for the latch to release and slide it back off the feeder bank. ■



Warning



Heavy. 17 kg. Do not drop. Turn off the RoadRunner and disconnect facilities before removing it from a feeder bank.





Connecting Power and Air

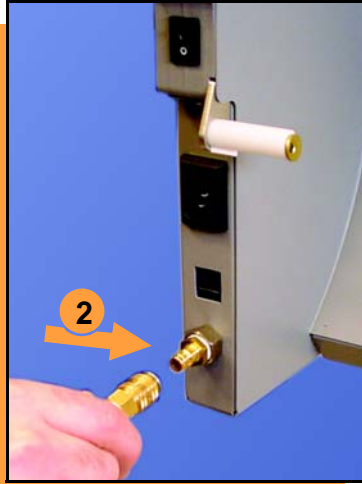
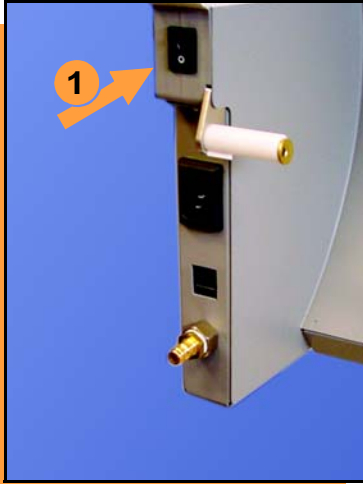

To connect the power and the air:

1. Turn the RoadRunner power switch to the Off (0) position.
2. Grasp the air hose *behind* the “quick connect” collar and push it firmly onto the male fitting. The collar must be allowed to move back as it goes onto the fitting.

NOTE: Compressed air must be clean and dry at approximately 5.25 kgf/cm² (75 psi).



Warning:



Point Air Hoses Away From Body.
Wear Approved Eye Protection.

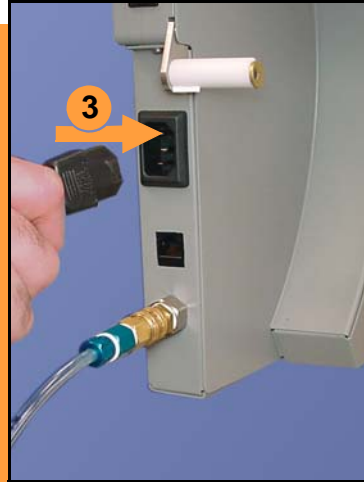
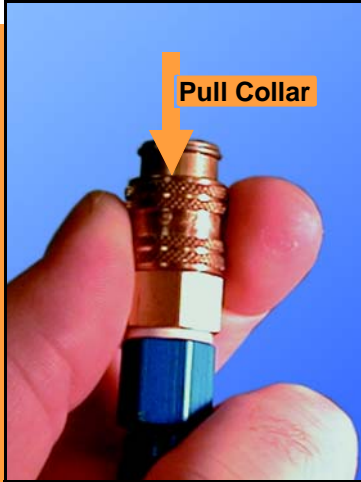

3. Connect to a grounded power source using a cable with a standard IEC 320 plug.

RoadRunner accepts power between 100 and 240 VAC, 50/60Hz.

NOTE: To disconnect the air hose, grasp the collar on the connector and pull back.

The air line is equipped with a "quick connect" that will stop airflow when disconnected. ■





Running the Self-Test

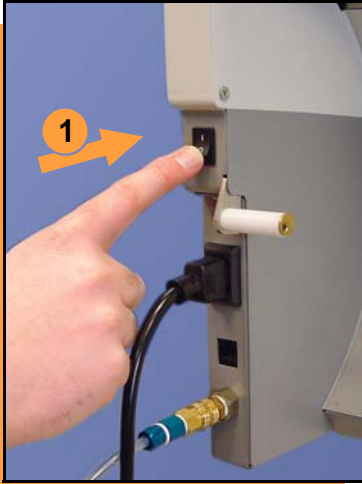

To run the Self-Test:

1. Turn the power switch On (I).

All the control panel indicator lights will come on. When the Self-Test finishes, the blue light will remain on and the version number will display.

If all the indicator lights start blinking, a serious error has occurred. Turn the unit off then on again. If the error continues, have the unit serviced.

2. If no errors display, RoadRunner is operation ready. ■



Chapter 3

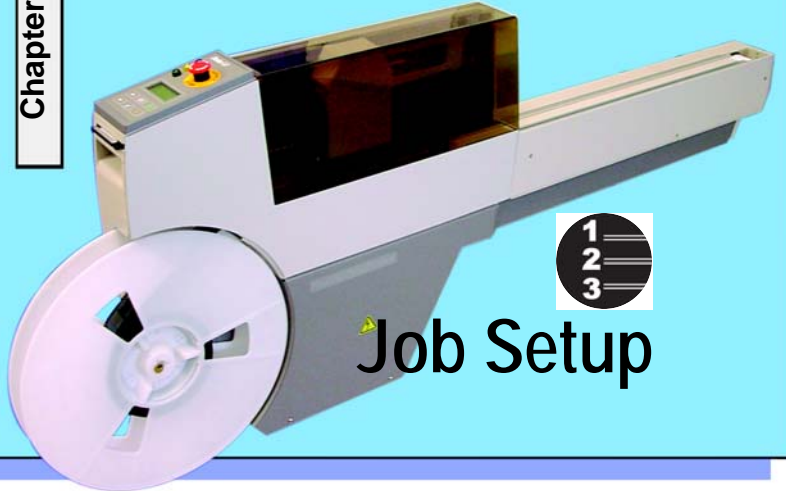

Inserting a Job Card 20

Changing the Precisor 22

**Changing the
Actuator Plate..... 24**

**Changing the
Socket Adapter..... 26**

Adjusting the Tape-In Module 28

Loading a Reel of Devices 30

Aligning the Tape Pockets 32

Inserting a Job Card



To run a job, insert a TaskLink job card in the PCMCIA card slot. Use only TYPE I or TYPE II PCMCIA cards.

To insert a job card:

1. If the power switch is on, make sure the blue lamp is lit.



Caution:

Electrostatic Discharge May Cause Damage.
Discharge Static Against Common Ground
Prior to Inserting Job Card.

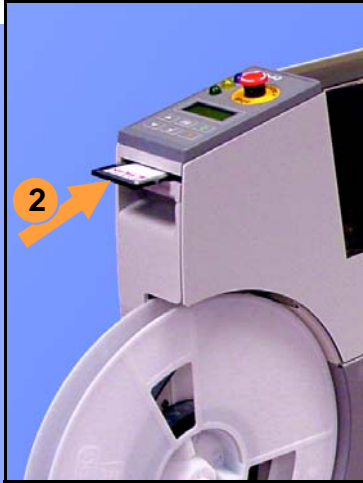

2. Slide the job card into the PCMCIA card slot.

NOTE: When fully inserted, the job card extends slightly from the PCMCIA card slot.

3. The Card Eject button can be pushed to remove the card.

Do not eject the card unless the blue lamp is lit (or the power is off). ■

Changing the Precisor

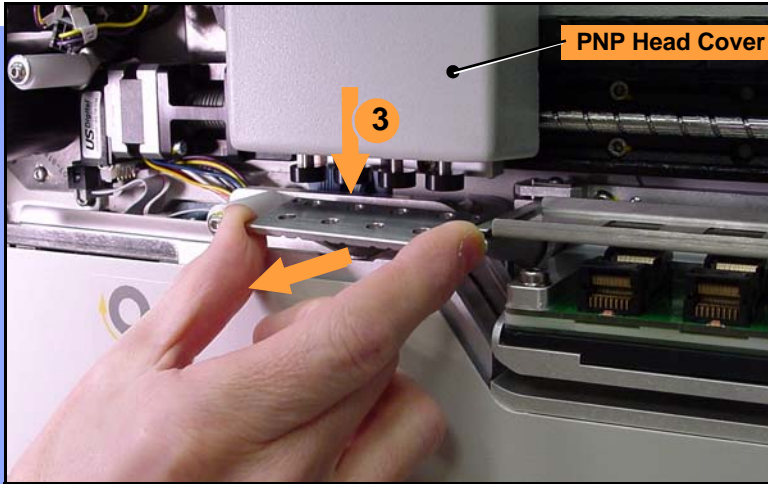

To change the precisor:

1. Select Job, then End, wait for the blue lamp to light and turn the power Off (0).
2. Lift off the Robotics Cover.
3. Starting at one end, pull the precisor down off the magnet, and then pull the other end off.

The PNP Head Cover can be removed for easier access.



Warning:



Pinch Warning. Keep Hands Away From Moving Parts.

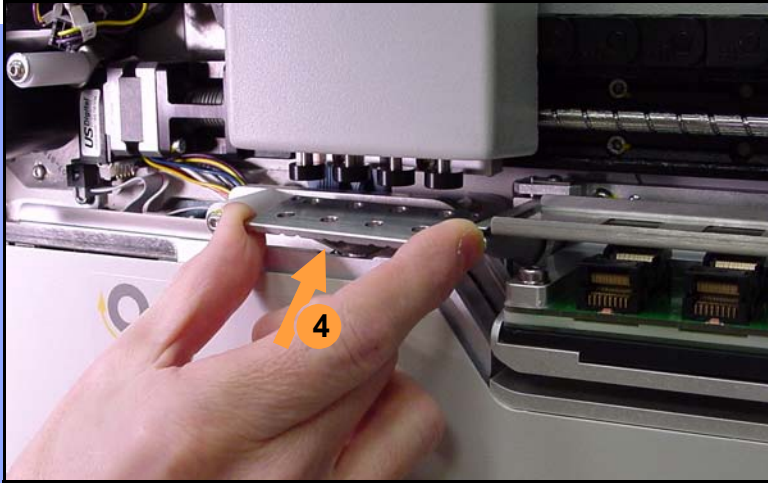

4. When inserting the new precisor, make sure that the part number faces up and that the small holes near the precisor edge fit over the dowel pins on the PNP head.

There should be no visible gap between the precisor and the head. ■

Changing the Actuator Plate

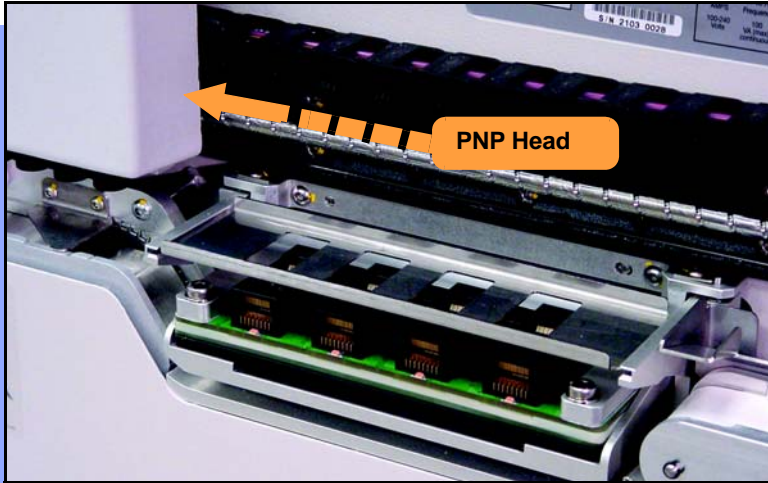

To change the Actuator Plate:

1. Select Job, then End, wait for the blue lamp to light and turn the power Off (0).
2. Lift off the Robotics Cover.

Once power is off, the PNP Head can be moved by hand to allow access to the Actuator Plate.



Warning:



Pinch Warning. Keep Hands
Away From Moving Parts.

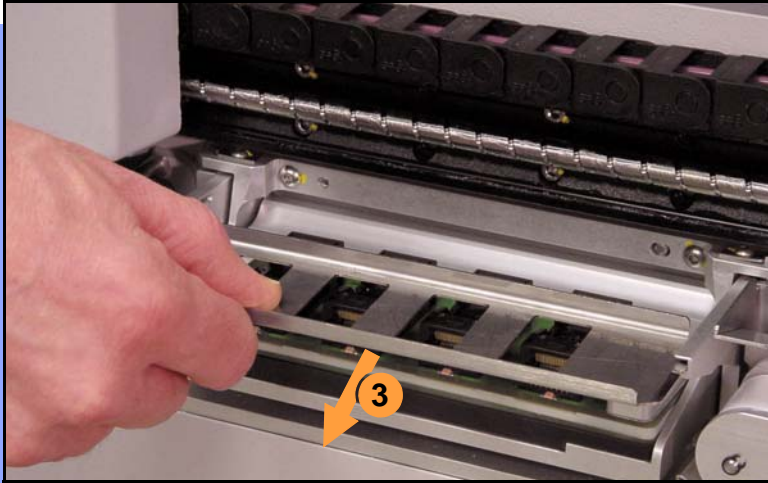

3. Pull the Actuator Plate to slide it out of the grooved brackets.

NOTE: The Actuator Plate must be out to access or change the Socket Adapter.

To change the Socket Adapter, see the procedure on the following page. ■

Changing the Socket Adapter

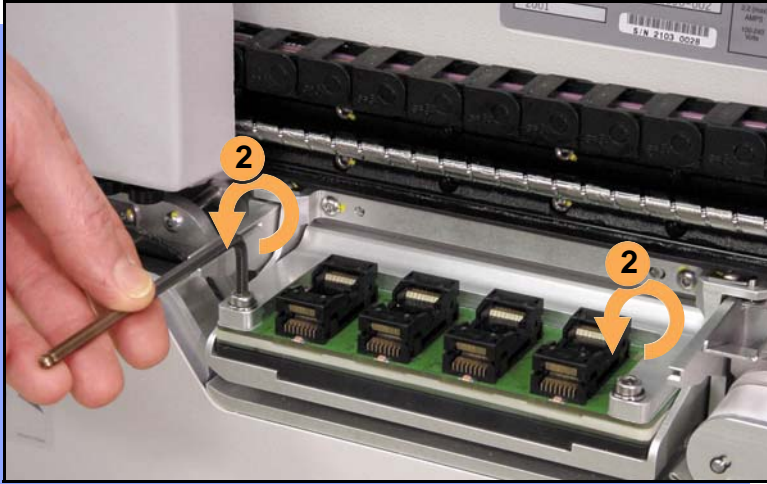

To change the Socket Adapter (with the Actuator Plate removed):

1. Make sure the power is Off (0).
2. Unscrew the two captive screws and lift the adapter bracket.



Warning:



Pinch Warning. Keep Hands
Away From Moving Parts.



Caution:



Electrostatic Discharge May Cause Damage.
Discharge Static Against Common Ground.

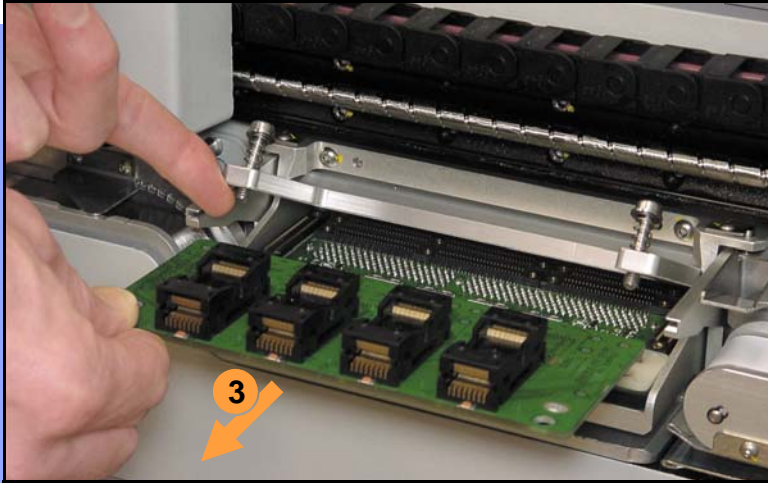

3. Without touching the gold contact surfaces on the bottom of the adapter, lift the adapter free.
4. Insert the correct adapter, making sure that it seats on the dowel pins.
NOTE: Each type of device may have its own Socket Adapter.
5. Tighten the screws and replace the Actuator Plate. ■

Adjusting the Tape-In Module

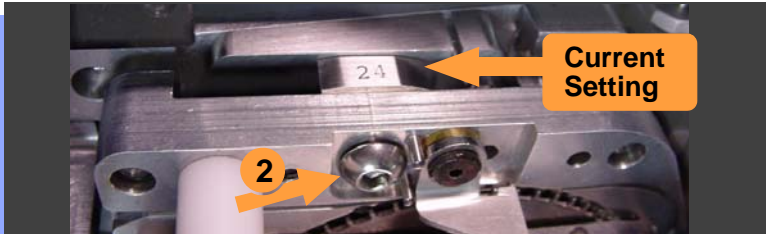

If you have an Adjustable Tape-In Module, you may need to adjust the tape width.

Adjustable Tape-In Module only—
If the etched number on the 3-Position Spacer does not match your tape width dimension (mm):

1. With the power off (0), move the PNP Head out of the way.
2. Loosen the Position Locking Screw using a 4 mm Allen wrench.

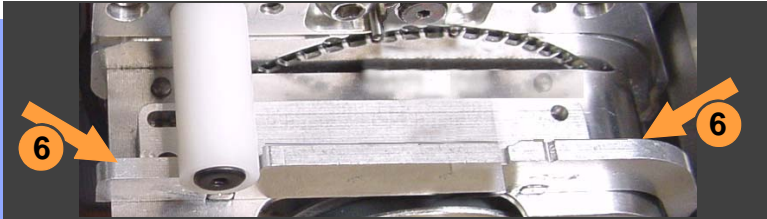
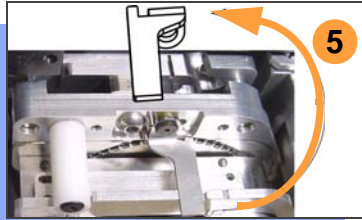
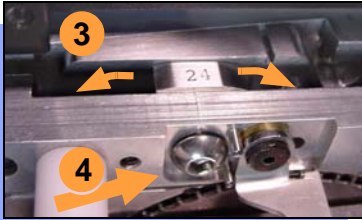

3. Rotate the 3-Position Spacer with your finger until you read 16, 24 or 32, corresponding to your tape width.
4. Retighten the Position Locking Screw.
5. Rotate the Peel Bar counterclockwise 180 degrees to the up position.
6. Lift and move the magnetic Front Track to the position that fits your tape width.
7. Rotate the Peel Bar back down. ■

Loading a Reel of Devices

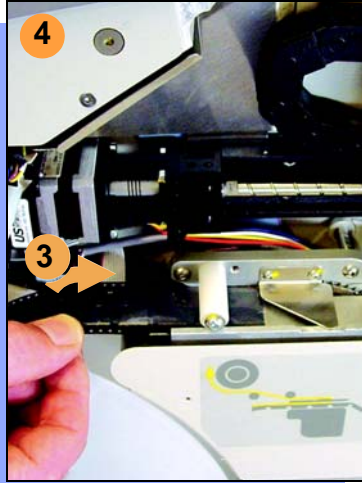
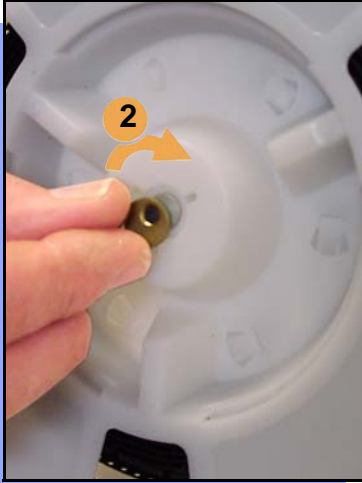

To load and thread device tape:

1. Place a reel onto the RoadRunner spindle.
2. Lock the reel in place by rotating the brass button on the spindle end.
3. Insert the device tape into the Tape-In Module and onto the sprocket.
4. Select Advance Pocket from the operator menu, then press the Up Arrow button.

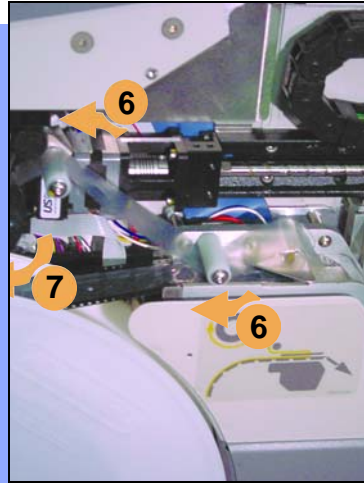
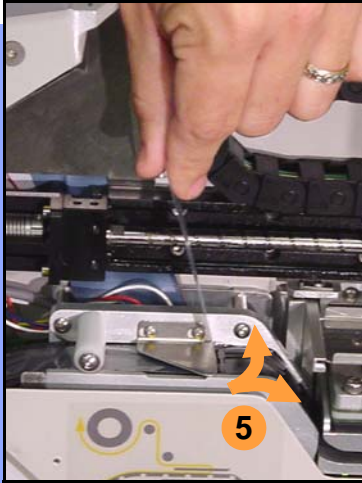

5. When the tape is advanced past the Peel Bar, separate the cover tape from the device tape.
6. Thread the cover tape up through the cover tape path and attach it to the Cover Tape Take-Up Reel. Advance the tape as necessary.

NOTE: A small piece of adhesive tape may be needed to stick the cover tape to the Take-Up Reel.

7. Turn the Take-Up Reel to take up slack cover tape.
8. Align the tape pockets as described in the following procedure. ■

Aligning the Tape Pockets

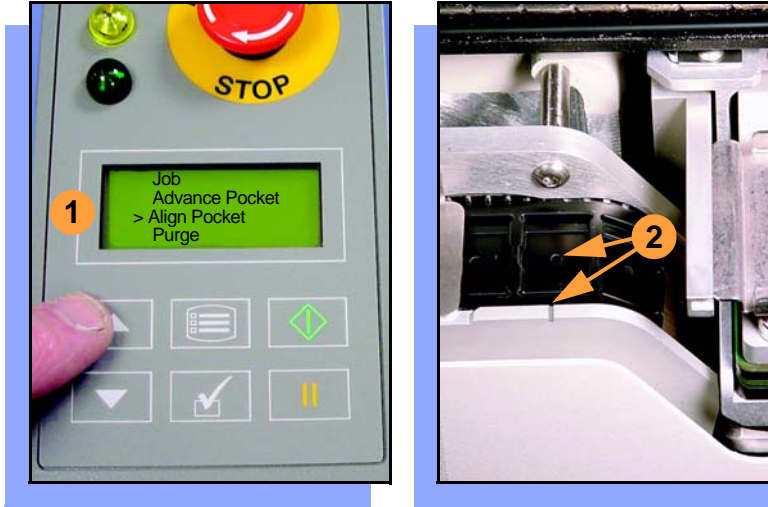

To align the tape pockets:

1. Select Align Pocket from the Operator Menu.
2. Press the Up Arrow button to advance the tape until the next tape pocket center hole is approximately centered at the pick point alignment mark. *Do not* advance devices past the pick point. They may fall and jam the tape path. Do not use the Down Arrow to align.

NOTE: *This aligning procedure must be performed each time power is applied, such as after releasing the Emergency Stop.* ■



Chapter 4

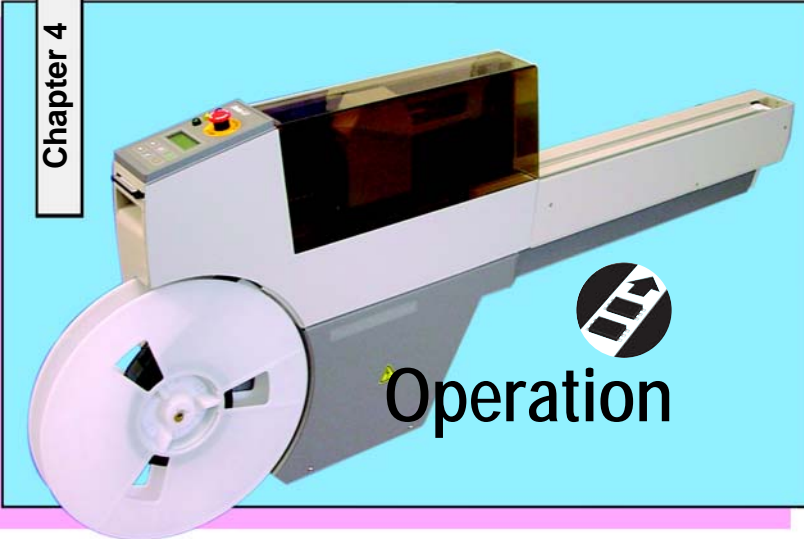

Running a Job	34
Pausing or Stopping a Job	35
Ending a Job	36
Emptying the Reject Bin	38
Emptying Cover Tape	39
Shutting Down	40
Restarting a Job	42





Running a Job

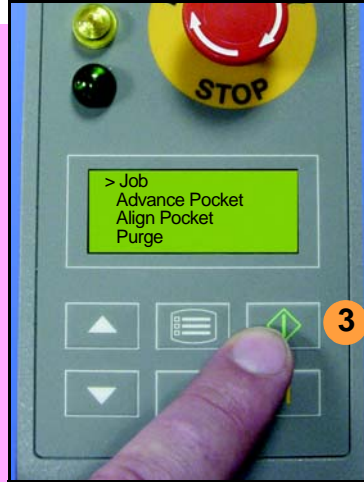
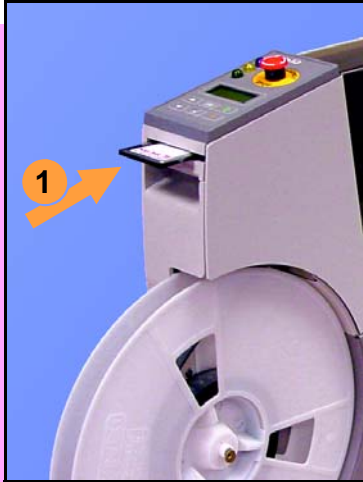

To run a job:

1. Insert a job card in the PCMCIA card slot.
2. Clear the conveyor belt of any unneeded devices.
3. Press Start.

The green lamp will start blinking.

When the programmed devices reach the assembly machine pick point, the belt will pause and the green lamp will stay lit without blinking. ■



Pausing or Stopping a Job

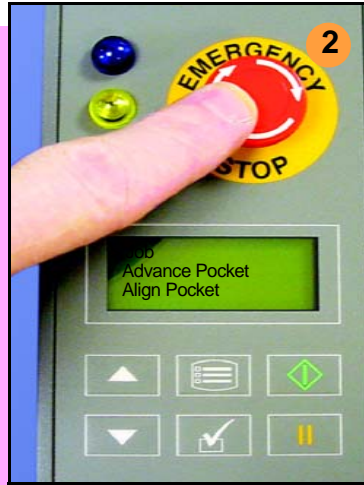
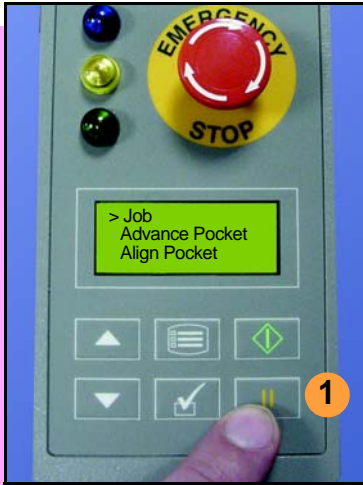

To pause at the end of the current operation:

1. Press Pause on the control panel.

To instantly stop in an emergency situation:

2. Press the Emergency Stop button. ■



Warning



Electrical shock hazard. The E-Stop does not stop electricity to RoadRunner.





Ending a Job

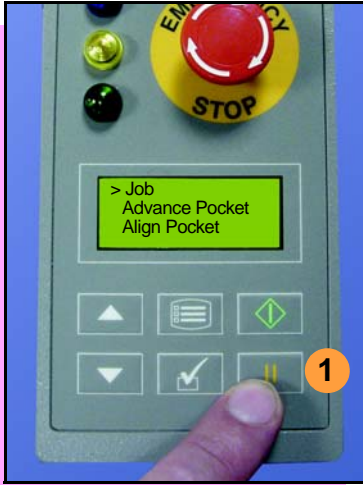

Whenever you are going to change job cards, you must first end the current job.

To end the current job:

1. Press Pause button.
2. Choose End from the Job Menu. Job is in the main menu.

The system will finish processing devices and place the devices on the belt, but no additional devices will get picked from the tape.

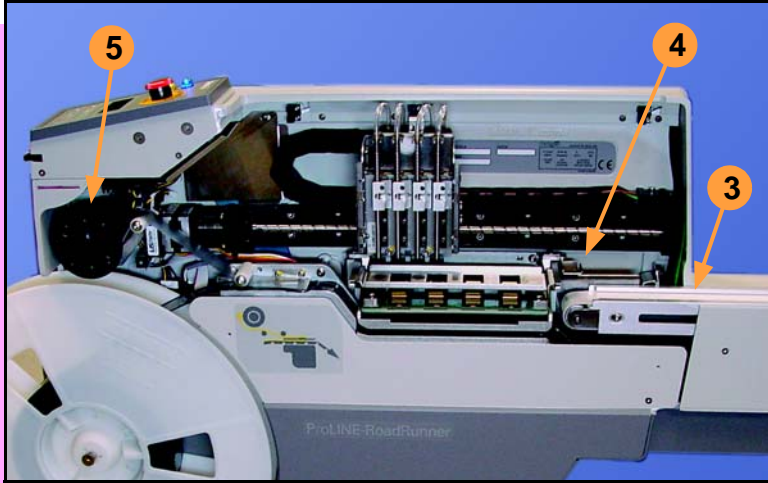

3. Clear away excess devices from the conveyor belt.
4. Empty the Reject Bin. (See next heading.)
5. Empty the Cover Tape Take-Up Reel. (See “Emptying Cover Tape” ahead several pages.) ■





Emptying the Reject Bin

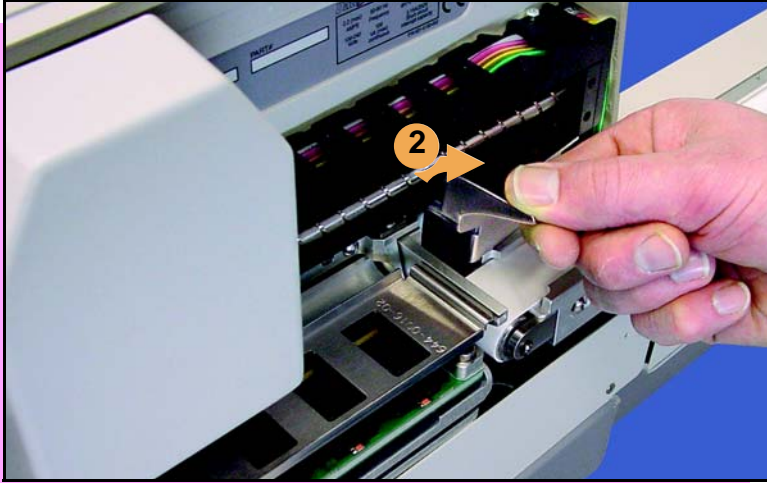

To empty the Reject Bin:

1. Press the Pause button.
2. Pull the Reject Bin out by grabbing the finger tab and then lift up and out.

When reinserting the Reject Bin, be sure the bin is *completely* lowered so that the tab is positioned out of the path of the probes. ■



Warning:



Pinch Warning. Keep Hands
Away From Moving Parts.



Emptying Cover Tape

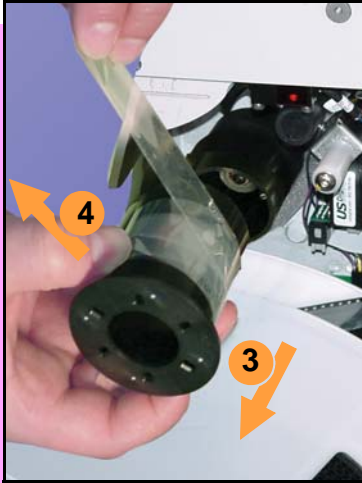

To empty the Cover Tape Take-Up Reel:

1. Press Pause.
2. Cut the cover tape, leaving enough slack to reattach.
3. Pull the Take-Up Reel straight out. (Reels with slots require rotating before pulling off.)
4. Unwind the used cover tape and discard it.
5. Replace the Take-Up Reel—slide it on and rotate it to line up with the pins, and push (or twist). ■



Warning:



Pinch Warning. Keep Hands
Away From Moving Parts.





Shutting Down

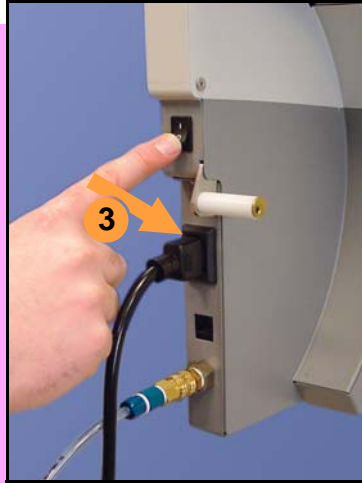
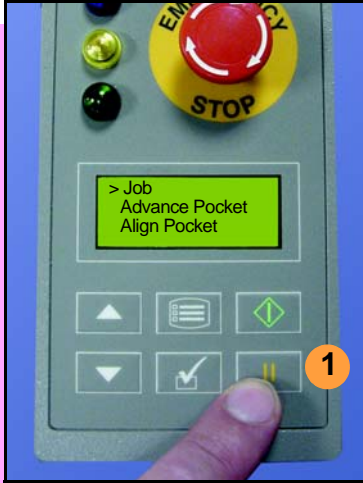

To shut down RoadRunner:

1. Press Pause.
2. Select End Job from the Job Menu and wait for all devices to be placed on the belt.
3. Turn the power Off (0).
4. Remove devices from the conveyor belt.

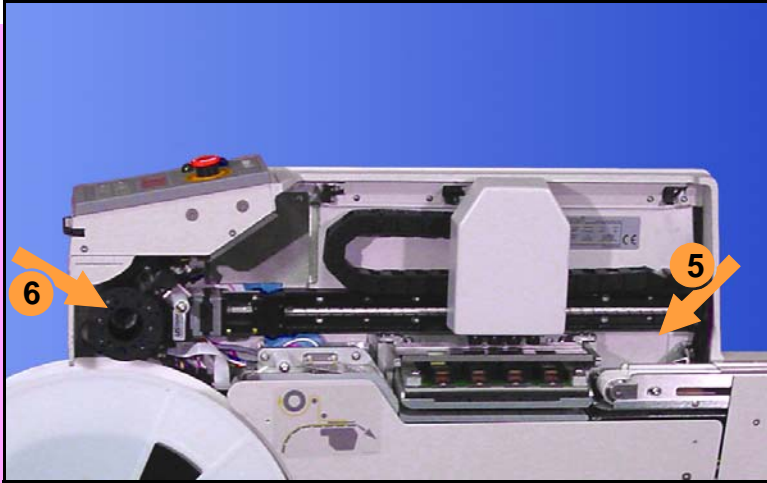

5. Empty the Reject Bin.
6. Remove and empty the Take-Up Reel. (For more, see the previous heading.)
7. Remove the air hose or shut off the air flow.

NOTE: When disconnecting the air hose, pull the connector collar back as you pull the connector off. ■





Restarting a Job

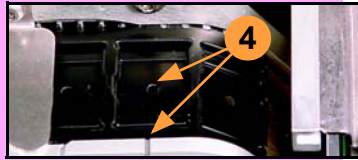
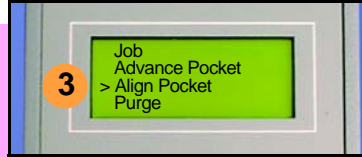

To restart RoadRunner after a pause or an emergency stop:

1. Turn the Emergency Stop button clockwise to release it, if needed.
2. Press Menu until the main level menu is displayed
3. Select Align Pocket.
4. Press the Up Arrow to advance the device tape until the *next* pocket center hole lines up with the alignment mark.
5. Press Start.

The job will resume. ■



Chapter 5

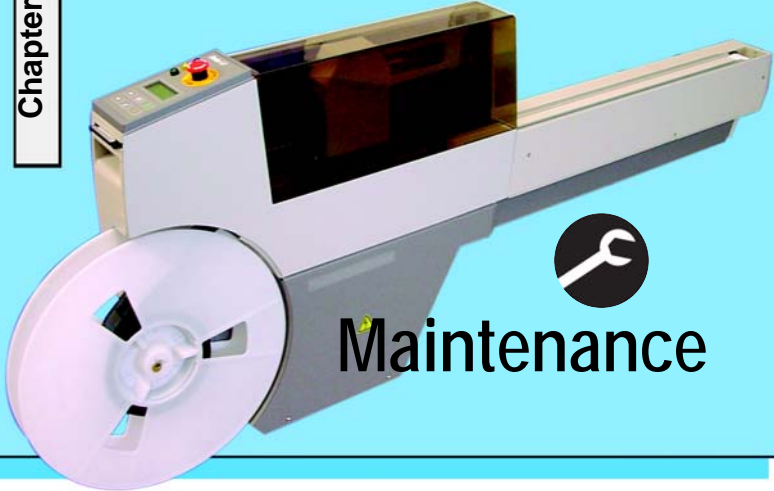

Cleaning with Air..... 44
Cleaning with Alcohol..... 45
Running the Self-Test..... 46





Cleaning with Air

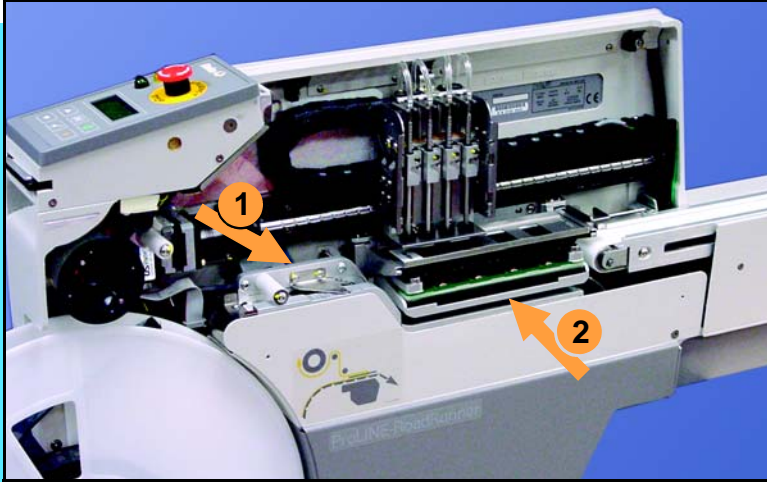

To prevent dust accumulation, inject compressed air into the following component areas:

1. Tape-In Module (weekly).
2. Sockets (daily). Sockets should be opened and closed by hand while air is injected.

NOTE: Compressed air must be clean and dry. ■



Warning:



Point Air Hoses Away From Body.
Wear Approved Eye Protection.



Cleaning with Alcohol

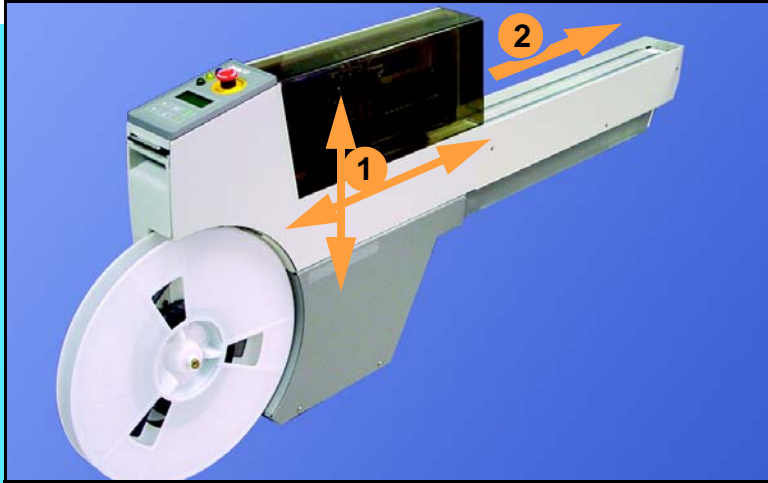

To prevent dust and oil accumulations, clean the following component areas with isopropyl alcohol on a lint-free cloth.

1. Chassis and Covers (every 3 months).
2. Conveyor belt (daily). See "Device Rotation" in the Troubleshooting chapter.

NOTE: Dry the conveyor belt before rotating it.

These intervals are based on running 40,000 devices weekly. ■





Running the Self-Test

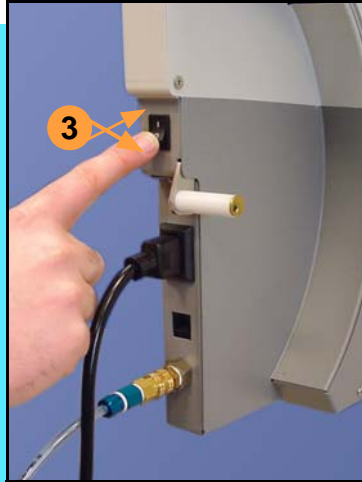
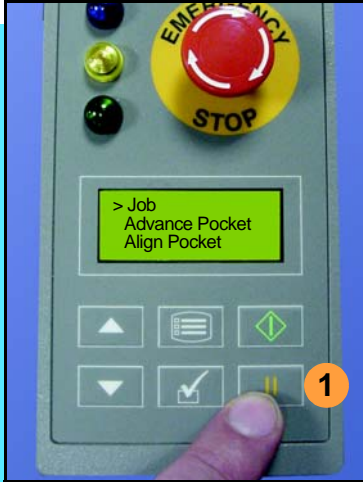

Run the Self-Test procedure approximately once a week.

To run the Self-Test procedure:

1. Press Pause.
2. Clear all devices from the sockets and from the conveyor belt.
3. Toggle the power switch off and then back on.

The Self-Test will run, checking the condition of the components.

4. Check the display for system errors. ■



Chapter 6

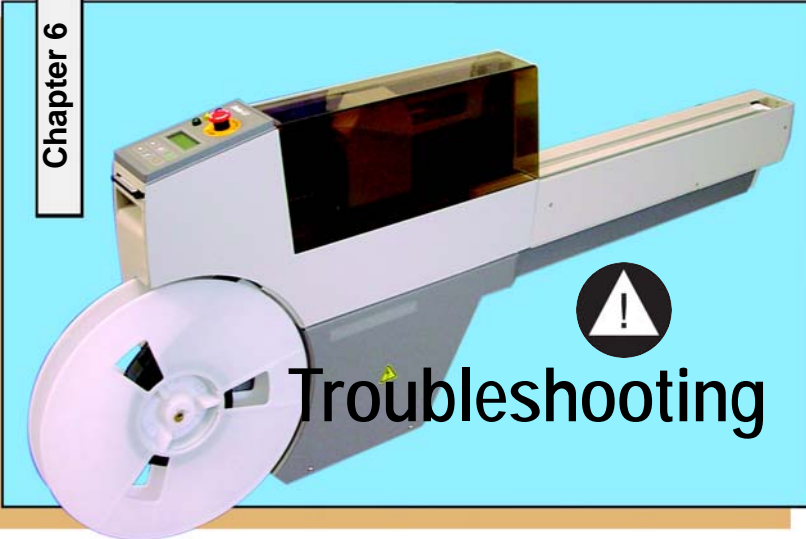

Viewing Errors.....	48
Enabling a Socket.....	50
Clearing Jammed Tape.....	51
Device Rotation.....	52
Technical Support.....	53





Viewing Errors



To view and correct errors:

1. Messages will appear in the keypad display.
2. Check the condition—tape path, Reject Bin, etc.—implied by the message.

If you cannot correct the error condition, contact a service technician.

3. Press Menu to remove the message.

If there are other error messages the next one will appear.

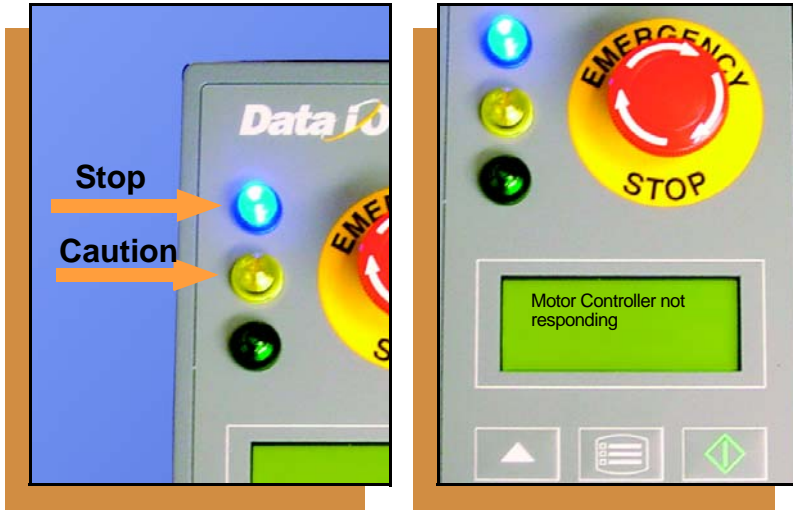

Some common error messages are listed below. For more information see “Troubleshooting” in the *ProLINE-RoadRunner Owner’s Manual*.

Lamp Color	Error Message
No change in lamps	Card not present
Yellow	Reject Bin needs to be emptied
Blue	Cover tape broken
Blue	Emergency Stop is activated ¹
Blue	Motor controller not responding

¹Twist the Emergency Stop button to release it. ■





Enabling a Socket



If a socket repeatedly becomes disabled, RoadRunner should be serviced.

To re-enable a disabled socket:

1. Choose Socket from the top level menu.
2. Arrow down and select the disabled socket from the Socket menu. (A dot appears.)
3. Press the Up Arrow button to re-enable the socket.

NOTE: To disable a probe, disable the probe's corresponding socket. ■



Clearing Jammed Tape

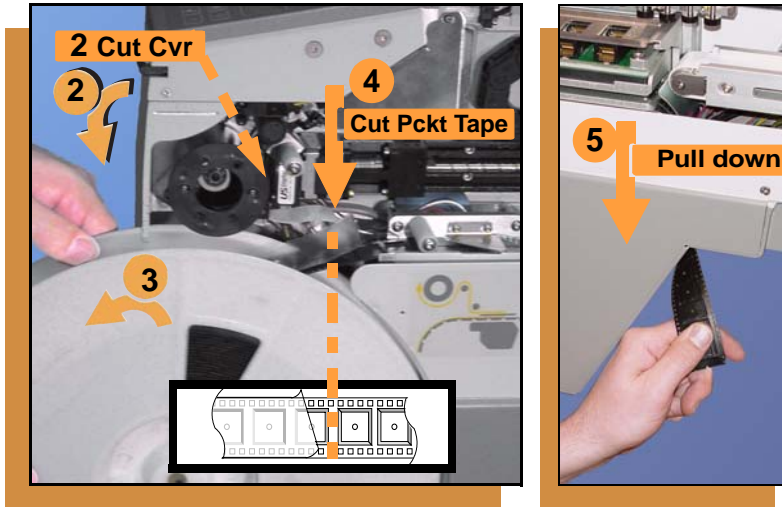

If the tape jams, an error message displays and the blue lamp illuminates.

To clear the tape path:

1. Press the Emergency Stop button (to continue the job later) or select Job, then End. Turn the power off.
2. Unroll one turn of cover tape and cut it near the Take-Up Reel.
3. Pull the tape out backwards until the cover tape end is free.
4. Cut the device tape.
5. Pull the tape out where it exits to remove it from the machine.
6. Trim away any flaws before reloading. ■





Device Rotation

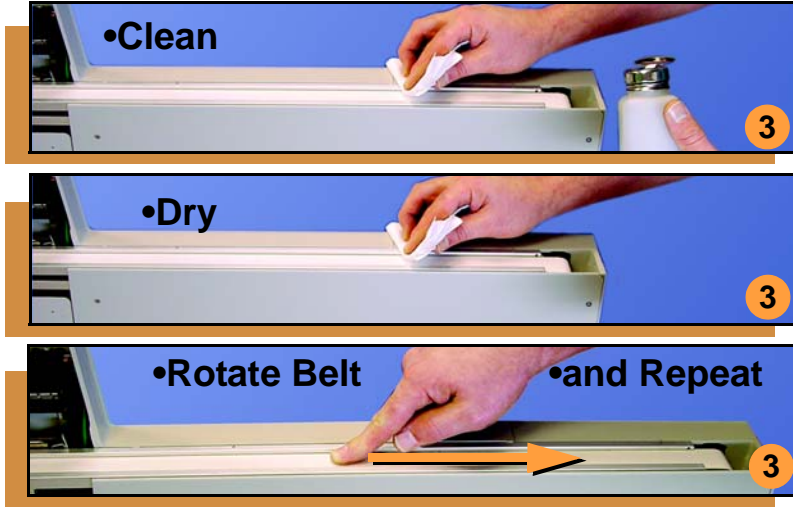

If devices rotate excessively on the conveyor belt:

1. Press Pause. Wait for all the devices to get picked from the belt.
2. Press the Emergency Stop.
3. Remove the Dust Cover and clean only the exposed surface of the conveyor belt with isopropyl alcohol on a lint-free cloth, *then dry it*. Rotate the belt by hand and repeat until clean.
4. To continue, replace the Conveyor Dust Cover, release the Emergency Stop button and press Start. ■



Technical Support

Contact your local Data I/O representative.

To find your local representative, go to
<http://www.dataio.com/contact/repsearch.asp>

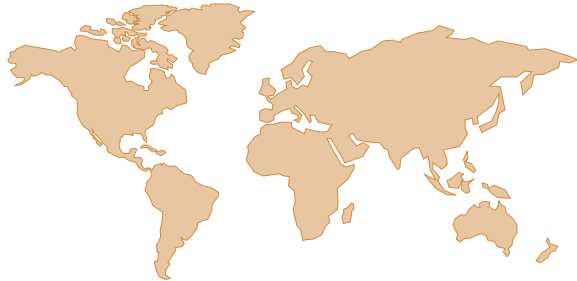

Worldwide

Data I/O Corporation

Shipping address:

10525 Willows Road N.E.
Redmond, WA USA 98052

Mailing address:

P.O. Box 97046
Redmond, WA USA 98073-9746

Telephone: 425-867-6870 USA Only: 1-800-332-8246

Fax: 425-882-1043

E-mail: support@data-io.com

You can also find answers by visiting our Knowledge Base on our Web site at www.dataio.com, then click **Support**, then **Knowledge Base Search**.

