



## **Series 48 Lasers**

**Model Number:**

**48-1-28(W)**

**48-2-28(W)**

**48-5-28(W)**

**J Version**

# **Operation and Service Manual**

RELEASE v5.0

7/19/99

**Synrad, Inc.**  
**6500 Harbour Heights Parkway**  
**Mukilteo, WA 98275**  
**(425) 349-3500**  
**email: [synrad@synrad.com](mailto:synrad@synrad.com)**  
**FAX: (425) 485-4882**  
**In U.S.: 1-800-SYNRAD1**



# Important Notice of Modification for

## Synrad J- 48 Series CO<sub>2</sub> Lasers

Effective September 1, 1999

**This information is important if you use, or plan to use, the DB-9 connector for external control/monitoring of the laser.**

### Keyswitch version

A “remote interlock” function has been added to the keyswitch version of the laser via the DB-9 connector. This function will provide the “remote interlock” capability described in the latest CDRH regulations and is in addition to the “remote keyswitch” capability provided on earlier J-version lasers.

For the laser to “lase”, pin 6 must be connected to pin 7 and pin 3 must be grounded. On the DB-9 connector, both pins 2 and 4 are suitable grounds. For more detailed information please consult the manual (sect. 4.3)

All lasers are supplied with an appropriately jumpered shorting plug installed. However, if this is removed (for instance, to attach a customer-wired DB9 connector), it is essential that pin 3 be grounded for the laser to operate.

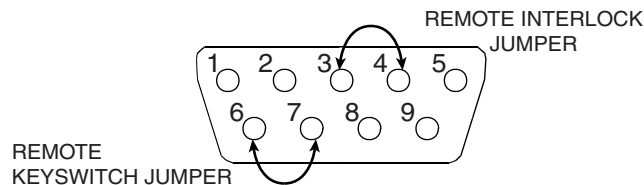

### OEM version

For those lasers supplied in OEM (-S) version (i.e. without a keyswitch), the “remote interlock” function has been bypassed internally. These lasers will function identically to J-version lasers manufactured prior to August, 1999.

For OEM customers wishing to access the “remote interlock” function via the DB-9 connector, please contact the factory for details.





# **Series 48 Lasers**

## **J VERSION**

# **Operation and Service Manual**

Part Number 900-00007-02

SYNRAD, Inc.  
6500 Harbour Heights Parkway  
Mukilteo, WA 98275  
1-800-SYNRAD1  
TEL: (425) 349-3500  
FAX: (425) 485-4882  
E-Mail: [synrad@synrad.com](mailto:synrad@synrad.com)  
Web site: <http://www.synrad.com>



## Table of Contents

|          |  |    |
|----------|--|----|
| <b>1</b> | <b>Safety and Regulatory Compliance</b> .....              | 1  |
| 1.1      | CDRH Requirements/Safety Features.....                     | 1  |
| 1.2      | EMI and Safety Compliance .....                            | 3  |
| 1.2.1    | Federal Communications Commission (FCC) Requirements.....  | 3  |
| 1.2.2    | European Union (EU) Requirements .....                     | 4  |
| 1.3      | Declaration of Conformity .....                            | 5  |
| 1.4      | Warning Labels ...   | 6  |
| 1.5      | Operation and Service Manual Precautionary Notations ..... | 6  |
| 1.6      | General Hazards ..   | 6  |
| <b>2</b> | <b>Theory of Operation</b> .....                           | 9  |
| 2.1      | Technical Specifications .                                 | 9  |
| 2.2      | Technology Overview .....                                  | 10 |
| 2.3      | Description of Physical Operation .....                    | 11 |
| 2.3.1    | Plasma Section ...   | 11 |
| 2.3.2    | Optical Resonator .....                                    | 11 |
| 2.4      | Laser Power Control.....                                   | 12 |
| 2.4.1    | Tickle Pulse.....  | 13 |
| 2.4.2    | PWM (Clock) Frequency .....                                | 13 |
| 2.4.3    | Low Frequency Gated Operation .....                        | 15 |
| 2.5      | Description of Electrical Operation.....                   | 15 |
| 2.5.1    | PWM Control Circuitry... ..                                | 15 |
| 2.5.2    | Fault Shutdown Conditions.....                             | 16 |
| 2.5.3    | Power-On Reset... ..                                       | 16 |
| 2.5.4    | RF Driver IV .....   | 16 |
| 2.6      | Duo-Lase Operation (48-5) .....                            | 17 |
| <b>3</b> | <b>Physical Features</b> .....                             | 19 |
| 3.1      | Controls and Indicators ...                                | 19 |
| 3.1.1    | Shutter Switch .....                                       | 19 |
| 3.1.2    | Power On LED .....   | 20 |
| 3.1.3    | Lase LED. ....   | 20 |
| 3.1.4    | Keyswitch .....  | 20 |
| 3.1.5    | Fuse .....   | 21 |
| 3.1.6    | DB9 Connector....  | 21 |
| 3.1.7    | Command Input... ..  | 21 |
| 3.1.8    | DC Power Cables .....                                      | 21 |
| 3.1.9    | Auxiliary Power ..   | 21 |
| 3.1.10   | Laser Exit Aperture .....                                  | 21 |
| 3.1.11   | Diode Pointer Power Connector..                            | 21 |
| 3.1.12   | Mounting of Optical Accessories .....                      | 21 |

# **Table of Contents**

(Continued)

|                   |  |    |
|-------------------|--|----|
| <b>4</b>          | <b>Interface Requirements</b> .....          | 23 |
| 4.1               | UC-1000 Universal Laser Controller .....     | 23 |
| 4.2               | DC Power Supply .....                        | 23 |
| 4.2.1             | 48-1 / 48-2 Model .....                      | 23 |
| 4.2.2             | 48-5 Model .....                             | 23 |
| 4.3               | DB9 Connector....                            | 23 |
| 4.4               | Cooling Requirements.....                    | 25 |
| 4.4.1             | 48-1 / 48-2 Cooling .....                    | 25 |
| 4.4.2             | 48-5 Cooling.....                            | 27 |
| <b>5</b>          | <b>Unpacking and Setup</b> .....             | 29 |
| 5.1               | Unpacking/Initial Inspection.....            | 29 |
| 5.2               | Mounting . .....                             | 29 |
| 5.3               | System Interconnections . .....              | 30 |
| 5.3.1             | 48-1 / 48-2 Interconnections .....           | 30 |
| 5.3.2             | 48-5 Interconnections.....                   | 30 |
| <b>6</b>          | <b>Operating Instructions..</b> .....        | 33 |
| 6.1               | General ....                                 | 33 |
| 6.2               | Turn-On/Check-Out .....                      | 33 |
| 6.3               | Operation in Pulsed Mode.....                | 34 |
| 6.4               | Operation in Continuous Wave (CW) Mode.....  | 35 |
| 6.5               | PC Control of Laser.....                     | 35 |
| <b>7</b>          | <b>Maintenance and Troubleshooting</b> ..... | 37 |
| <b>8</b>          | <b>Return for Factory Service</b> .....      | 39 |
|                   | Service Request Form .....                   | 40 |
| <b>Appendix A</b> | <b>Supporting Documentation</b>              |    |
| <b>Appendix B</b> | <b>UC-1000 Universal Laser Controller</b>    |    |



## List of Figures

|   |   |      |      |
|---|---|------|------|
| 1.1   | European Compliance Mark..                                    | 4    |      |
| 1.2   | Declaration of Conformity ....                                | 5    |      |
|   |   |      |      |
| 2.1   | Average Laser Output vs. Percent PWM Duty Cycle.....          | 10   |      |
| 2.2   | Physical Schematic.....                                       | 11   |      |
| 2.3   | Beam Characteristics. ....                                    | 12   |      |
| 2.4   | Typical PWM Drive Signal... ..                                | 12   |      |
| 2.5   | Tickle Pulse Waveform.....                                    | 13   |      |
| 2.6   | Typical 5 kHz Command Input Waveforms For Gated Operation ... | 14   |      |
| 2.7   | Modulation Waveforms.....                                     | 14   |      |
| 2.8   | RF Driver IV . ....   | 18   |      |
|   |   |      |      |
| 3.1   | 48-1, 48-2 Physical Features Location Diagram.....            | 19   |      |
| 3.2   | 48-5 Physical Features Location Diagram ....                  | 20   |      |
|   |   |      |      |
| 4.1   | DB9 Jumper Plug .....   | 24   |      |
| 4.2   | 48-5 (25W) Cooling Fan Placement..                            | 25   |      |
| 4.3   | 48-1 / 48-2 Laser Cooling Kit .....                           | 26   |      |
| 4.4   | 48-5 Laser Cooling Kit.....                                   | 27   |      |
|   |   |      |      |
| 5.1   | Typical System Interconnection Diagram.....                   | 32   |      |
|   |   |      |      |
| Appendix A  |   |      |      |
| 48-1  | Label Location Diagram .....                                  | A-42 |      |
| 48-2  | Label Location Diagram .....                                  | A-43 |      |
| 48-5  | Label Location Diagram .....                                  | A-44 |      |
| 48-1  | Outline/Mounting Diagram.....                                 | A-45 |      |
| 48-2  | Outline/Mounting Diagram.....                                 | A-46 |      |
| 48-5  | Outline/Mounting Diagram.....                                 | A-47 |      |
| Interconnect Schematic, Model 48 Series Lasers..... |   |      | A-48 |
| Schematic, J Series Control Board....               |   |      | A-49 |
|   |   |      |      |
| Appendix B  |   |      |      |
| UC-1000   | Front/Rear Panels ..  | B-1  |      |

## **List of Tables**

|     |                                      |    |
|-----|--------------------------------------|----|
| 1.1 | Series 48 Safety Features .....      | 2  |
| 1.2 | European Union Directives ... ..     | 4  |
| 2.1 | Series 48 Specification Table .....  | 9  |
| 4.1 | DB9 Connector Pin Assignments.....   | 24 |
| 7.1 | Series 48 Troubleshooting Table..... | 37 |

# Introduction

Thank you for purchasing a Series 48 laser from SYNRAD, Inc. The Series 48 family of lasers incorporates the latest developments in sealed carbon dioxide devices, combining the best features of both waveguide and free space CO<sub>2</sub> laser technology in an innovative aluminum tube design. J Series lasers utilize state-of-the-art surface mount electronics, newly patented RF excitation technology, and fully CE-compliant systems for EMI containment, heat removal, and laser safety. In the 10-50W range of continuous optical output, these lasers represent an ideal balance between proven, mature laser tube technology and reliable, simplified electronic control.

All information necessary to safely operate and maintain the laser is provided in this manual. The information is organized in several chapters and is arranged as follows:

- Chapter 1 Safety and Regulatory Compliance
- Chapter 2 Theory of Operation
- Chapter 3 Physical Features
- Chapter 4 Interface Requirements
- Chapter 5 Unpacking and Setup
- Chapter 6 Operating Instructions
- Chapter 7 Maintenance and Troubleshooting
- Chapter 8 Return for Factory Service

In addition to the information contained in the chapters described above, supporting data has been provided in several appendices located after Chapter 8. In the event additional information is required for your application, please contact SYNRAD at 1-800-SYNRAD1.

**Please read this manual completely before using your laser. To prevent injury to personnel or damage to the laser, follow all safety precautions, handling, and setup instructions as described herein.**



# Chapter 1

## Safety and Regulatory Compliance

### 1.1 CDRH Requirements/Safety Features

Series 48 lasers are designed to comply with requirements imposed by the Radiation Control for Health and Safety Act of 1968. Under this act, the Food and Drug Administration issued a performance standard for laser products, 21 CFR 1040.10 and 1040.11. This performance standard was developed to protect public health and safety by imposing requirements upon manufacturers of laser products to provide indication of the presence of laser radiation, by providing the user with certain means to control radiation, and by assuring adequate warnings to all personnel of the potential hazard, through the use of product labels and instructions.

Federal regulations require that all laser products manufactured on or after August 2, 1976, be certified as complying with the performance standard. The manufacturer must demonstrate the product's compliance with the standard prior to certification or introduction into commerce by furnishing to the Center for Devices and Radiological Health (CDRH) reports pertaining to the radiation safety of the product and the associated quality control program. Failure to provide the required reports or product certification is a violation of Section 360B of the Radiation Control for Health and Safety Act of 1968.

Product features incorporated into the design of Series 48 lasers to comply with CDRH safety requirements are integrated as panel controls or indicators, internal circuit elements, or input / output signal interfaces (terminated at a DB9 connector installed on the side panel of the laser). Specifically, these features include a keyswitch (keyswitch version), remote interlock, a laser aperture shutter, fault output signals to indicate failure of internal electronics (control board or RF driver) or an actual or impending overtemperature condition, and a 5-second delay between keyswitch actuation and lasing. Incorporation of certain features is dependent on the version (OEM or keyswitch).

All product features are summarized in Table 1.1. The table indicates the laser version on which a feature is available, the type and description of the feature, and if the feature is required by, and complies with, CDRH regulations.

In addition to the safety features described above, common safe operating practices should be exercised at all times when actively lasing. Follow all safety precautions specified throughout this manual to prevent exposure to direct or scattered laser radiation. Use of controls or adjustments or performance of procedures other than those specified herein may result in exposure to hazardous invisible laser radiation, damage to, or malfunction of the laser. Severe burns will result from skin exposure to the laser beam. Always wear safety glasses with side shields to reduce the risk of damage to the eyes when operating the laser.

Safe operation of the laser requires the use of an external beam block to safely block the beam from traveling beyond the desired work area. Use firebrick or a similar non-scattering, non-combustible material as the beam block. **NEVER** use organic material or metals as the beam block; organic materials, in general, are apt to combust or melt and metals act as specular reflectors.

## Ch.1 Safety and Regulatory Compliance

**Table 1.1 Series 48 Safety Features**

| FEATURE                         | VERSION                      | DESCRIPTION  | CDRH REQUIRED |
|---------------------------------|------------------------------|--|---------------|
| Keyswitch                       | Keyswitch                    | Panel control. ON/OFF switch. Key cannot be removed in the ON position.  | Yes           |
| Power Indicator                 | OEM <sup>1</sup> / Keyswitch | Panel indicator (green). Indicates that DC power is available for the laser. LED illuminates when keyswitch is turned to ON, the remote keyswitch is closed and no faults exist.   | Yes           |
| Lase Indicator                  | OEM / Keyswitch              | Panel indicator (red). Indicates that laser is in Lase mode. LED illuminates when laser beam is active. The brightness of the LED is related to duty cycle. Higher duty cycles (higher laser output) produce brighter illumination.  | Yes           |
| 5-Second Delay                  | OEM / Keyswitch              | Circuit element. Disables laser output for 5 seconds after keyswitch is turned to ON position and remote keyswitch is closed. Defeatable by internal DIP switch.   | Yes           |
| Power-On Reset                  | OEM / Keyswitch              | Circuit element. Disables laser if input power is removed and then later reapplied (power failure) while the keyswitch and remote keyswitch are still closed. Operator must reset the keyswitch, or remote keyswitch, to restore operation. Defeatable by internal DIP switch. | Yes           |
| Remote Interlock                | OEM / Keyswitch              | Circuit element. Allows laser to be shut down from a remote interlock such as a door or housing switch. Operator must reset the keyswitch, or remote keyswitch, to restore operation.  | Yes           |
| Remote Keyswitch                | OEM / Keyswitch              | Circuit element. Allows operator to turn laser on or off from a remote location. A series extension of the keyswitch circuit.  | No            |
| Over / Under Voltage Protection | OEM / Keyswitch              | Circuit element. Laser fault shutdown will occur if supply voltage falls below +15V or rises above +36V. Power-down sequence, keyswitch reset, or remote keyswitch reset is required to restore operation.   | No            |
| Reverse Voltage Protection      | OEM / Keyswitch              | Circuit element. Internal diode protects internal circuitry from reverse input voltages. The external fuse will blow.  | No            |
| Over-Temperature Protection     | OEM / Keyswitch              | Circuit element. Over-temperature shutdown will occur when the temperature of the tube reaches 60°C ±2°C. Power-down sequence, keyswitch reset, or remote keyswitch reset is required to restore operation.  | No            |
| PWM Failure Protection          | OEM / Keyswitch              | Circuit element. Disables laser if output power exceeds the Command input by 20% or more due to electronics failure. Power-down sequence, keyswitch reset, or remote keyswitch reset is required to restore operation.   | No            |
| Fault Signal                    | OEM / Keyswitch              | Signal output. Latches to a logic low state to indicate a fault shutdown has occurred.   | No            |
| Message Signal                  | OEM / Keyswitch              | Signal output. Pre-shutdown temperature warning latches to a logic low state when tube temperature reaches 54°C ±2°C.  | No            |
| Warning Labels                  | OEM / Keyswitch              | Labels. Attached to various external locations of the laser housing to warn personnel of potential hazards.  | Yes           |

1 On OEM versions (no keyswitch) the Power indicator illuminates and the five-second delay begins when DC power is applied to the laser.

## **1.2 EMI and Safety Compliance**

Series 48 lasers are designed to comply with certain Federal Communications Commission (FCC) and European Union (EU) directives that impose product performance requirements relating to electromagnetic compatibility (EMC) and product safety characteristics for industrial, scientific, and medical (ISM) equipment. The associated directives and specific provisions to which compliance is mandatory for Series 48 lasers are identified and described in Section 1.2.1 and Section 1.2.2.

### **1.2.1 Federal Communications Commission (FCC) Requirements**

The United States Communication Act of 1934 vested the Federal Communications Commission (FCC) with the authority to regulate ISM equipment that emits electromagnetic radiation in the radio frequency spectrum. The purpose of this regulation is to prevent harmful electromagnetic interference from affecting authorized radio communication services in the frequency range above 9 kHz.

The FCC regulations that govern ISM equipment are fully described in the *Code of Federal Regulations* (CFR) 47, Part 18. Series 48 lasers have been tested and found to comply with 47 CFR, Part 18 by demonstrating performance characteristics that have met or exceeded the requirements.

#### **Information to the User**

The following information is provided to comply with the requirements of 47 CFR, Part 18, Section 213.

Interference Potential - In our testing, SYNRAD, Inc. has not discovered any significant electrical interference traceable to Series 48 lasers.

Measures to Correct Interference - If you suspect your Series 48 laser interferes with other equipment, take the following steps to minimize this interference:

1. Route the laser's DC power cables away from signal cables connected to the equipment that is experiencing interference problems.
2. Use shielded cables to and from the equipment that is experiencing interference problems.
3. Install bisected Ferrite on the laser's DC power cables; locate them as close as possible to the laser housing.

Caution to the User: The Federal Communications Commission warns the user that changes or modifications of the unit not expressly approved by the party responsible for compliance could void the user's authority to operate the equipment.

## ***Ch.1 Safety and Regulatory Compliance***

---

### **1.2.2 European Union (EU) Requirements**

The European Norm (EN) document EN60825-1 was developed to protect persons from laser radiation by imposing requirements upon manufacturers of laser products to provide an indication of laser radiation; to classify laser products according to the degree of hazard; to require both user and manufacturer to establish procedures so that proper precautions are adopted; to ensure adequate warning of the hazards associated with accessible radiation through signs, labels, and instructions; to improve control of laser radiation through protective features; and to provide safe usage of laser products by specifying user control measures.

The European Union's Electromagnetic Compliance (EMC) directive 89/336/EEC is the sole directive developed to address EMI issues in electronic equipment. In particular, the directive calls out European Norm (EN) documents that define the emission and immunity standards for specific product categories. For Series 48 lasers, the standard EN55011 defines the radiated RF emissions limit. The generic standard EN50082-1 defines immunity requirements published by the International Electrotechnical Commission (IEC). Refer to Table 1.2 for a summary of EU performance requirements pertaining to Series 48 lasers.

**Table 1.2 European Union Directives**

| DIRECTIVE | SCOPE  | PROVISION   |
|-----------|--|---|
| EN55011   | Limits and methods for measurement of radio frequency disturbance characteristics for industrial, scientific, and medical (ISM) equipment. | Emitted RF Radiation shall not exceed limits described in document CISPR11.   |
| EN50082   | Generic standard governing ISM performance relating to radiated emissions and ESD sensitivity, and immunity to transient bursts.           | Immunity to electrostatic discharge levels defined in document IEC801, Part 2.<br><br>Equipment shall operate normally when exposed to RF emissions at levels described in document IEC801, Part 3.<br><br>Immunity to electrical fast transient bursts at levels defined in document IEC801, Part 4. |

After a product has met the requirements of all pertinent EU directives, the product can bear the official compliance mark of the European Union depicted in Figure 1.1.



**Figure 1.1 European Compliance Mark**



Series 48 lasers have demonstrated performance characteristics that have met or exceeded the requirements of EN 60825-1 and the EMC directive 89/336/EEC.

### **1.3 Declaration of Conformity**

A Declaration of Conformity is provided to certify that EMC performance levels of Series 48 lasers are compliant with applicable EU directives and standards.

| <b>DECLARATION OF CONFORMITY</b>  |   |   |
|---|---|---|
| <b>Applicable EU Directive(s):</b>  | 89/336/EEC  | EMC Directive   |
| <b>Applicable Standards/Norms:</b>  | EN55011<br>EN60825-1<br>EN50082-1<br><br>IEC801-2<br>IEC801-3<br>IEC801-4 | Radiated, Class A, Group 1<br>Laser Safety<br>Generic Immunity<br><br>Electrostatic Discharge<br>RF Radiated<br>Fast Transients |
| <b>Manufacturer:</b>  | SYNRAD, Inc.<br>6500 Harbour Heights Parkway<br>Mukilteo, WA 98275        |   |
| <b>Model Number</b>   | <b>Date of Compliance</b>   |   |
| J48-1   | Oct. 15, 1998   |   |
| J48-2   | Oct. 15, 1998   |   |
| J48-5   | Oct. 15, 1998   |   |
| SYNRAD, Inc. hereby declares that the equipment specified above conforms to the above Directive(s) and Standard(s). |   |   |

**Figure 1.2 Declaration of Conformity**

## ***Ch.1 Safety and Regulatory Compliance***

---

### **1.4 Warning Labels**

Each Series 48 laser is shipped with several different types of labels attached to the laser chassis. These labels identify apertures from which laser radiation is emitted, power output levels, and precautions relating to performance characteristics. Refer to Appendix A (Pages A2 - A4) for label location diagrams.

### **1.5 Operation and Service Manual Precautionary Notations**

There are two types of precautionary notations used throughout this manual.

#### **WARNING**

**A WARNING notation is used to identify a process or procedure that could result in exposure to laser radiation.**

#### **CAUTION**

A CAUTION notation is used to identify a process or procedure that could result in damage to the laser if not properly performed.

### **1.6 General Hazards**

#### **WARNING**

**Always wear eye protection around an exposed laser beam. Direct or diffuse laser radiation can inflict corneal injuries. Select protective eyewear that blocks 10.6  $\mu\text{m}$  CO<sub>2</sub> laser radiation. Eyewear protects against scattered energy, and is not intended to protect against direct viewing of the beam or reflections from metallic surfaces. Protective eyewear for 10.6  $\mu\text{m}$  CO<sub>2</sub> laser radiation is available from SYNRAD, Inc.**

**Enclose the beam path whenever possible. Direct or diffuse laser radiation can seriously burn human or animal tissue.**

**Refer to and follow the laser safety precautions in ANSI Z136.1-1993, *American National Standard for Safe Use of Lasers*. Procedures listed under the Standard include: appointment of a Laser Safety Officer, operation of the product in an area of limited access by trained personnel, servicing of equipment only by trained and authorized personnel, and posting of signs warning of the potential hazards.**

**WARNING**

Processing of materials can generate air contaminants such as vapors, fumes, and/or particles that may be noxious, toxic, or even fatal. Material Safety Data Sheets (MSDS) for materials being processed should be thoroughly evaluated and the adequacy of provisions for fume extraction, filtering, and venting should be carefully considered. Review the following references for further information on exposure criteria:

*ANSI Z136.1-1993, American National Standard for Safe Use of Lasers, Section 7.3.*

*U.S. Government's Code of Federal Regulations: 29 CFR 1910, Subpart Z.*

*Threshold Limit Values (TLV's) published by the American Conference of Governmental Industrial Hygienists (ACGIH).*

**It may be necessary to consult with local governmental agencies regarding restrictions on venting of vapors.**

**CAUTION**

Use of controls or adjustments or performance of procedures other than those specified herein may result in hazardous radiation exposure.



## Chapter 2

# Theory of Operation

### 2.1 Technical Specifications

Technical information regarding Series 48 performance characteristics is summarized in Table 2.1.

Table 2.1 Series 48 Specification Table

| CHARACTERISTICS                               | MODEL  |                      |                            |
|---|--|----------------------|----------------------------|
|   | 48-1   | 48-2                 | 48-5                       |
| Wavelength                                    | 10.57 to 10.63 microns   |                      |                            |
| Power Output:<br>Guaranteed <sup>(1)(2)</sup> | 10W  | 25W                  | 50W                        |
| Power Stability                               | ±10%   | ±5%                  |                            |
| Mode Quality                                  | TEM00 equivalent: 95% purity   |                      |                            |
| Beam Diameter/Divergence                      | 3.5mm/4mR  |                      |                            |
| Polarization                                  | Linear-vertical 50:1 extinction minimum  |                      | Random                     |
| Modulation/Rise or Fall Time                  | 150µs max, 10% - 90% (5 kHz PWM 20% & 50% duty factor, 1 kHz square wave gate)   |                      |                            |
| Electrical Control, Command Input             | Opto-isolated LED input - Positive logic – 20 kHz max frequency<br>High = On = +3.5V min, +10V max; Low = Off = +0.5V max, 0V min<br>6mA max load @ 5V (48-1, 48-2); 12mA max load @ 5V (48-5) |                      |                            |
| Electrical Control, Remote<br>Keyswitch Link  | On = Contact closure ≤ 10Ω, Off = Open Circuit ≥ 100KΩ<br>Contact Rating 50 VDC, < 2mA minimum (dry circuit)   |                      |                            |
| Electrical Control, Remote Interlock<br>Link  | On = Contact closure ≤ 10Ω, Off = Open Circuit ≥ 100KΩ<br>Contact Rating 50 VDC, < 2mA minimum (dry circuit)   |                      |                            |
| Electrical Power Input <sup>(2)</sup>         | 30-32 VDC, 7 A max.  | 30-32 VDC, 14 A max. | 30-32 VDC, 28 A max.       |
| Cooling Water <sup>(3)(4)</sup> :             |  |                      |                            |
| Heat Load, Max                                | 200W   | 400W                 | 800W                       |
| Flow Rate                                     | 0.5 GPM  | 0.8 GPM              | 1.5 GPM                    |
| Temperature                                   | 18 - 20°C  | 18 - 20°C            | 18 - 20°C                  |
| Thermal Shutdown                              | 60°C ±2°C, warning at 54°C ±2°C  |                      |                            |
| Beam Exit, Vertical Location                  | 1.09 inches from top plate, center   |                      | 1.22 inches from top plate |
| Weight  | 9 lb. (4.1 kg)   | 18 lb. (8.2 kg)      | 44 lb. (20 kg)             |
| Dimensions (W x H x L) <sup>(5)</sup>         |  |                      |                            |
| Inches  | 2.8 x 3.9 x 17   | 2.8 x 3.9 x 32       | 5.6 x 4.3 x 35             |
| Millimeters                                   | 71 x 99 x 432  | 71 x 99 x 813        | 142 x 110 x 890            |

- (1) Output power level is guaranteed for 12 months regardless of operating hours.
- (2) Minimum 30 VDC input voltage to obtain guaranteed output power.
- (3) Lasers with output power ≥50W must be water-cooled. Lasers with output <50W can be either water- or air-cooled depending on their duty cycle. For duty cycles > 50%, water-cooling is strongly recommended. Note that water-cooling improves power stability at any duty cycle.
- (4) Inlet cooling water temperature should always be maintained above the dew point to avoid condensation and water damage to the laser.
- (5) For overall height dimension, add 0.25 in to allow for top cooling fins.

### 2.2 Technology Overview

Series 48 lasers incorporate the latest technology in sealed carbon dioxide devices, combining the best features of both waveguide and free space CO<sub>2</sub> laser technology. The all-metal laser tube construction (U.S. Patent #4,805,182) features the ruggedness, stable optical support, and small size of waveguide lasers. Its larger bore (4.8 mm) eliminates the high optical power density of waveguide lasers with their predisposition to optical degradation and incorporates the mode purity and easy optical alignment of free space TEM<sub>00</sub> lasers. Low cost is achieved by using simple extruded and welded aluminum structures packaged together with compact, state-of-the-art RF power supplies. The laser is self-contained requiring only the application of power, cooling air or water, and a control signal. It is therefore ideally suited for overhead installation where the laser is gantry-mounted. No RF cable runs are required.

48 Series lasers emit a laser beam with a wavelength of 10.6  $\mu\text{m}$ . The beam shape is square at the laser output aperture, changing to circular at distances of approximately 1 meter or more from the laser. The laser beam diverges due to diffraction at a full angle of 4 milliradians, with the beam waist at the output aperture of the laser.

The method of RF excitation on which the Series 48 is based provides excellent discharge stability, easily controlled output power and modulation, and convenient interfacing to automated systems. Coupling between the RF driver and the laser is based on switching and transmission line technology (U.S. Patents # 5,008,894 and #5,602,865). The frequency of RF drive is approximately 45 MHz and is factory calibrated to match the resonant frequency of the plasma tube.

Power control of the laser beam is achieved by pulse width modulation (PWM) of the RF drive circuit. Modulation control can be used to gate the laser on and off at time intervals synchronized with automated processing equipment. It can also be used to control instantaneous power by adjusting the pulse width (PWM duty cycle) at a fixed modulation frequency. Both methods can be used simultaneously.

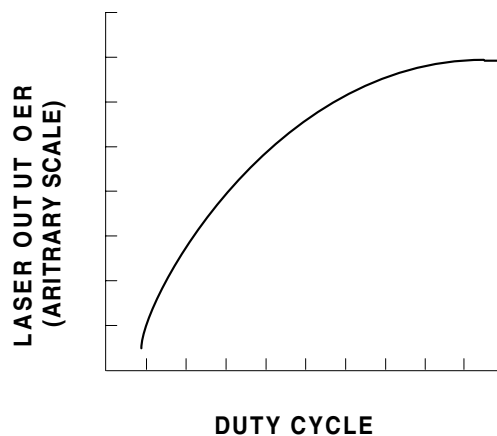

**Figure 2.1 Average Laser Output versus Percent PWM Duty Cycle**

As shown in Figure 2.1 above, the PWM on-time percentage (PWM duty cycle) exerts a non-linear power function as power saturation is approached, flattening out at approximately 95% duty cycle. SYNRAD recommends using a 95% maximum PWM signal since little or no increase in laser output power occurs between 95 and 100% PWM duty cycle. It is safe to operate at 100% duty cycle by eliminating all PWM control and simply applying on/off gating; however you can expect a 5% increase in power draw and heat load.

## 2.3 Description of Physical Operation

The laser consists of an RF excited plasma tube with an adjustable mirror on each end, mounted together with the RF drive assembly in a single aluminum chassis. Refer to Figure 2.2 for a schematic depicting the physical components of the laser.

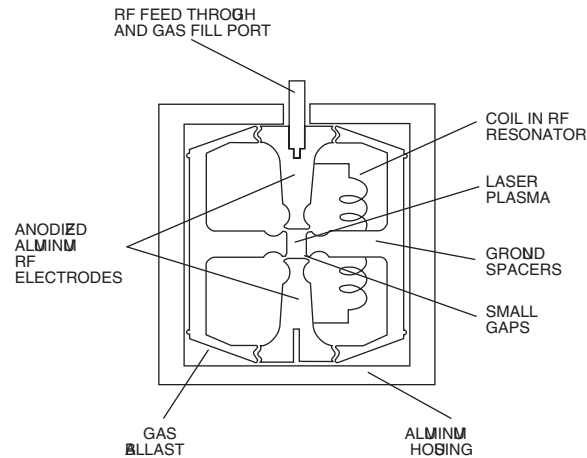

Figure 2.2 Physical Schematic

### 2.3.1 Plasma Section

The plasma tube is made of 2-inch square cross-section extruded aluminum tubing with pre-machined ends welded on. The mechanical and electrical arrangement of the internal electrode structure (U.S. Patent #4,805,182 and others) is shown schematically in Figure 2.2. The RF drive power is applied between the lower electrode and the plasma tube. The internal resonant circuit induces RF drive on the upper electrode that is 180 degrees out of phase with that of the lower electrode. Thus the voltage between the two RF electrodes is roughly twice that on either electrode, causing the plasma to form only in the 4.8-mm square bore region. The two sidewalls confine the plasma but carry negligible current. The RF electrodes are anodized to assure uniform distribution of RF power throughout the excitation volume. Waste heat is conducted away by all four metal sides of the bore to the outer walls of the plasma tube, where it is transferred to the chassis.

In contrast to waveguide lasers that have a closed bore periphery, the Series 48 lasers have four 0.02-inch slots (small gaps) extending longitudinally along the length of the bore (refer to Figure 2.2). These slots are used for electrical insulation between the two pairs of orthogonal electrodes. However, these slots are also effective for diffusion cooling of the laser gas.

### 2.3.2 Optical Resonator

The optical resonator consists of a 3-meter radius of curvature total reflector and a flat ZnSe output coupler with reflectivities of 95% or 92%. The mirrors are held on with Viton (fluorocarbon) elastomeric o-rings for factory adjustment by means of three Torx head 4-40 screws. No epoxy is used for sealing. The screws are secured by adhesive after alignment.

The 4.8-mm bore, in conjunction with the mirror curvature selected, limits the output beam to TEM<sub>00</sub> modes when the mirrors are properly aligned. Small variations in output power (up to 10%) are seen during warm-up as the cavity mirror spacing changes due to thermal expansion of the plasma tube. The output wavelength remains at or near 10.6  $\mu\text{m}$  (10.57 to 10.63  $\mu\text{m}$ ).

## Ch.2 Theory of Operation

The beam shape is square at the laser output aperture, changing to circular at distances of approximately 1 meter or more from the laser. The laser beam diverges due to diffraction at an angle of 4 milliradians (refer to Figure 2.3). The beam has a near gaussian profile in the far field (0.6m or more).

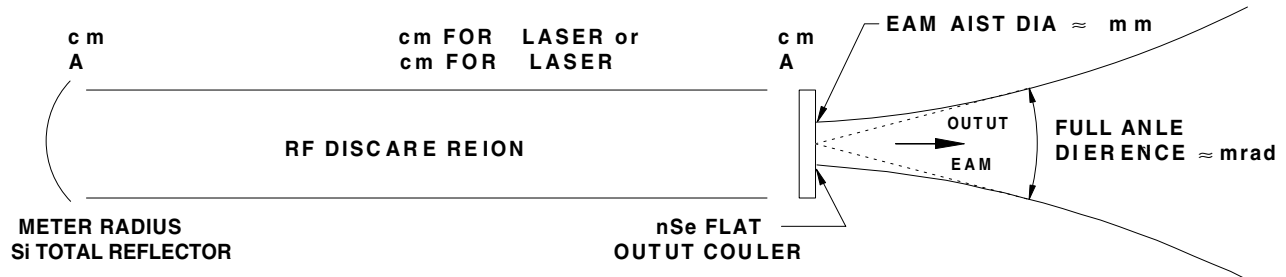

Figure 2.3 Beam Characteristics

## 2.4 Laser Power Control

To effectively control output power of Series 48 lasers, pulse width modulation (PWM) is used to vary the power-on time of the internal RF amplifier stage(s) which controls the short-term average RF drive applied to the laser electrodes. The required modulation source signal (refer to Figure 2.4) and the capabilities to control and vary that signal are provided by SYNRAD's UC-1000 Laser Controller. Using an alternate method to control laser output power requires consideration of key characteristics of Series 48 lasers as described in the following paragraphs.

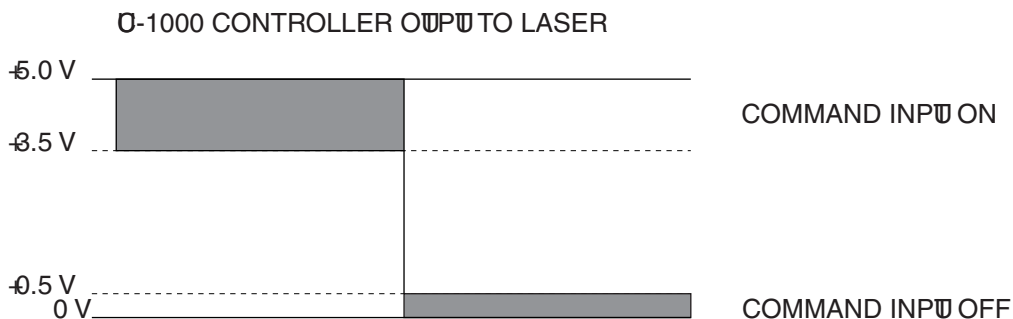

Figure 2.4 Typical PWM Drive Signal



### 2.4.1 Tickle Pulse

All Series 48 lasers require a 1  $\mu$ s ‘tickle’ pulse delivered at a 5 kHz clock frequency from the controller. If the user is supplying on/off Command pulses directly to the laser without a tickle pulse, the response time from the user’s Command pulse until laser emission is unpredictable and optical rise time will be degraded. This is due to the finite time required to create a plasma state within the laser tube and depends heavily on the amount of time that the laser has been off (no Command signal) before a pulse is applied. This inconsistent and unstable firing can cause problems in precision industrial uses where even short delays in firing are important. The tickle signal pre-ionizes the laser gas so that it is just below the lasing threshold. In this way, the laser can respond predictably and almost instantaneously to the user’s Command signal, even when there is considerable time delay (laser off time) between commands. This laser contains a precision pulse stretching circuit that is preset to accept a 1  $\mu$ s  $\pm$ 20% no-lase, tickle pulse. Lase threshold is preset for 3  $\mu$ s  $\pm$ 0.5  $\mu$ s based on a PWM and tickle frequency Command input of 5 kHz.

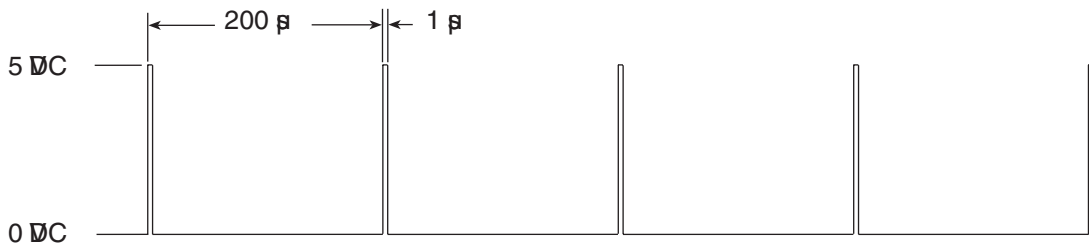

Figure 2.5 Tickle Pulse Waveform

### 2.4.2 PWM (Clock) Frequency

PWM duty cycle controls the laser’s power level so you can direct the laser to perform a variety of cutting and marking tasks. The standard PWM frequency is 5 kHz, which has a period of 200  $\mu$ s. The duty cycle of a PWM waveform is the percentage of the period that the output signal is high. If the amplitude of the 5 kHz signal is high for 100  $\mu$ s and low for 100  $\mu$ s, it has a 50% duty cycle. If the signal’s amplitude is high for 190  $\mu$ s and low for 10  $\mu$ s it has a 95% duty cycle. Refer to Figure 2.6 for waveforms.

## Ch.2 Theory of Operation

MEDIUM POWER LEVEL  
OUTPUT TO LASER  
FROM CONTROLLER  
(50% DUTY CYCLE)

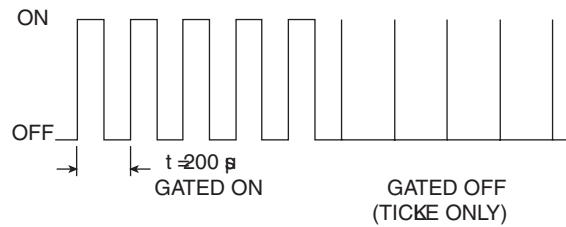

MAXIMUM POWER LEVEL  
OUTPUT TO LASER  
FROM CONTROLLER  
(95% DUTY CYCLE)

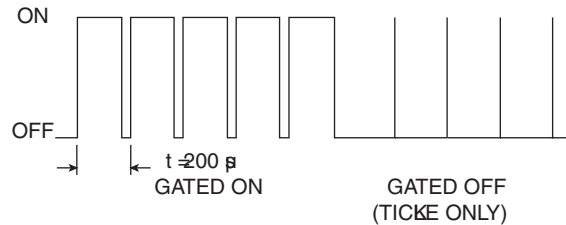

**Figure 2.6 Typical 5 kHz Command Input Waveforms for Gated Operation**

Series 48 lasers are designed to operate at PWM Command input frequencies up to 20 kHz. The choice of PWM frequency depends on the application. For most applications, the UC-1000 frequency of 5 kHz has proven to work well. Since the laser output follows the PWM input with a rise and fall time constant of  $\approx 100 \mu\text{s}$ , the laser output cannot precisely follow the Command input beyond PWM frequencies of 5 kHz with a duty cycle greater than 50% ( $5 \text{ kHz} = [1/100 \mu\text{s}] \times 50\%$ ). Typically, the depth of modulation at 50% duty cycle is 90 to 100% at 2 kHz and 60 to 80% at 5 kHz. Refer to Figure 2.7 for waveforms. For high-speed motion applications that cannot tolerate any ripple in the optical beam response but still need adjustable power levels, we recommend the use of PWM frequencies up to 20 kHz. At 20 kHz, the optical response no longer follows the Command input and is very nearly a DC value with just a small amount of ripple present.

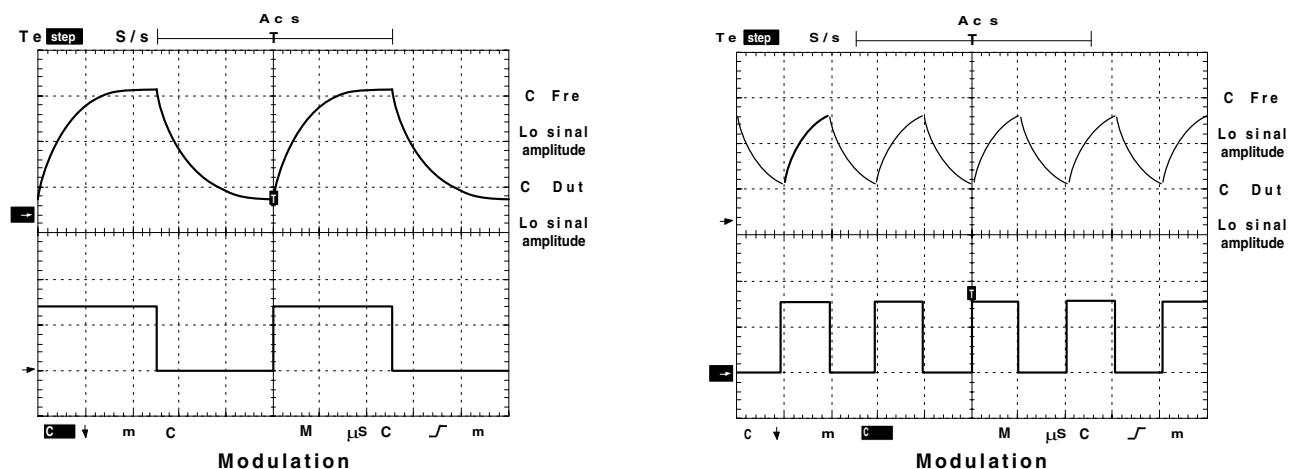

**Figure 2.7 Modulation Waveforms**

A 1  $\mu$ s wide tickle pulse at a frequency greater than 5 kHz may cause unwanted lasing. Special provisions must be made for maintaining a ready plasma state without lasing at frequencies greater than 5 kHz. For high-speed applications that require a PWM frequency beyond 5 kHz, consult the factory for more information. If a 1  $\mu$ s tickle is supplied at 5 kHz, PWM may be set to an in-dependent, higher frequency but must go to near zero (< 1%) duty cycle to ensure laser turn-off.

### **2.4.3 Low Frequency Gated Operation**

If your laser application requires relatively short gating pulses at repetition rates below 500 Hz, each gated pulse of laser output will exhibit some leading edge overshoot regardless of the PWM frequency. This is because a cooler lasing medium (the CO<sub>2</sub> gas) is more efficient than a hotter one. The effect is more pronounced at lower gating frequencies since the gas has more time to cool between lasing. If your application cannot tolerate this small spike of excess energy output on the leading edge of gated pulses, please consult SYNRAD.

## **2.5 Description of Electrical Operation**

Control of laser operation and power output levels is essentially performed using a single PCB. The Control PCB connects the modulated signal to the RF amplifier. It also provides electronics to monitor performance of RF control, output circuitry, input power, temperature, PWM accuracy, provides outputs to an externally accessible connector, and incorporates reverse polarity protection.

Functional differences between model types generally relate to the number of RF channels. Model 48-1 operation uses a single RF electrode requiring a single modulated RF drive input from the Control PCB. The 48-2 uses 2 RF electrodes and requires 2 RF channels while the 48-5 uses 4 electrodes and 4 RF channels (2 Control PCB's). For the purpose of this description, a single channel will be described. Model-specific details relating to differences in electrical characteristics will be individually discussed.

### **2.5.1 PWM Control Circuitry**

The Command input modulation source signal must be provided externally to the laser and is connected to the panel-mounted BNC connector labeled CTRL. This signal is connected to an opto-isolator, the output of which is applied to the PWM switch control circuit. The PWM switch control circuit gates the PWM switch off and on at the frequency and duty cycle controlled by the modulation source. When the PWM switch closes, a potential of 30 VDC is applied to the RF Driver. The PWM control circuit provides on/off gating of the PWM switch unless disabled by the 5-second delay, shutter switch, or the fault shutdown circuits.

The 5-second delay disables PWM output to the RF amplifier for a period of 5 (+ 0.5, - 0.0) seconds after the panel-mounted keyswitch and remote keyswitch link are closed (power ON). The 5-second delay is defeated for OEM customers who must provide this required safety feature elsewhere as part of their equipment integration. Please contact SYNRAD for details.

The shutter switch allows the operator to temporarily interrupt laser output during active lase modes. A mechanical lever physically blocks the exit aperture and at the same time actuates independent micro-switches that electrically interrupt power to the RF module by disabling the PWM input opto-isolator, forcing an "off" state.

## ***Ch.2 Theory of Operation***

---

### **2.5.2 Fault Shutdown Conditions**

The power-input circuit consists of a panel-mounted fuse for overcurrent protection, a dual Schottky shunt rectifier for reverse-voltage protection, a panel-mounted keyswitch, and a normally open MOSFET safety switch. Application of reverse-voltage will normally require fuse replacement.

The output of the keyswitch is connected to the control board through the DB9 user port. Note that the supplied DB9 jumper plug can be removed to allow the user to insert a remotely located relay or switch in series with the keyswitch. If the keyswitch is left on or is electrically bypassed, the user can turn the laser on and off, and reset fault shutdowns from a remote location.

The temperature warning message output (pin 5 of the DB9 connector) goes low when the laser tube temperature reaches  $54^{\circ}\text{C} \pm 2^{\circ}\text{C}$  and remains low until tube temperature falls  $2^{\circ}\text{C}$  below the trigger temperature. The warning message output does not shut down the laser.

Overtemperature fault shutdown occurs when laser tube temperature reaches  $60^{\circ}\text{C} \pm 2^{\circ}\text{C}$ .

Control board operation begins when the supply voltage rises above +18 VDC and remains below +36 VDC. After startup, the control board will shut the laser down if supply voltage falls below +15 VDC or rises above +36 VDC.

If an electronics failure causes the control board to output PWM power to the RF Drivers in excess of 20% of the commanded PWM input, a fault shutdown will occur.

To reset after any fault shutdown, correct the problem(s) then cycle the keyswitch (or remote keyswitch if one is present) or remove power to the laser for 30 seconds. During any fault shutdown, the fault shutdown output (pin 1 of the DB9 connector) will latch to low state until a keyswitch reset occurs.

### **2.5.3 Power-On Reset**

The Power-On Reset feature will not allow lasing to restart after a power failure or shutdown has occurred until the keyswitch or remote keyswitch is first cycled off (open circuit condition) and then back on (closed circuit). Power-On Reset is defeated via an internal DIP switch on all OEM (no keyswitch) versions. OEM customers must provide this required safety feature elsewhere as part of their equipment integration.

### **2.5.4 RF Driver IV**

RF power is provided by a patented (#5,602,865) single MOSFET transistor power oscillator operating in a tuned feedback circuit. The low-impedance MOSFET output is coupled to the relatively high-impedance laser tube electrode by a ceramic-substrate micro-strip transmission line integral to the RF Driver circuit board.

RF rise time is about 1  $\mu\text{s}$  to deliver a striking voltage of over 500V peak to the discharge electrodes. A pulse-stretching network on the control board widens the incoming Command input so that the tickle pulses delivered from the RF Driver are sufficient to provide a plasma ready state without emission. The RF drive is not centered on a frequency authorized for significant incidental radiation (ISM bands around 27 and 40 MHz). The power module must therefore be shielded effectively which is accomplished by integrating the plasma tube and drive into a single assembly. Refer to Figure 2.8 for the circuit schematic.

## **2.6 Duo-Lase® Operation (48-5)**

The 48-5 laser combines two laser tubes for twice the output of a standard laser. The output beams from two 25 watt sealed CO<sub>2</sub> tubes are combined optically to provide a single diffraction-limited beam at 50 watts.

The 50W unit uses two control boards and four RF drivers. The control boards are tied together electronically so that if a failure mode shuts down either board, both laser tubes are turned off. The control boards are equipped with individual fuses for each RF driver PWM output. In the event of an RF driver failure, only that fuse will open, allowing other RF drivers in the system to continue operating. Unless both fuses are open on a given control board, no shutdown will occur, nor is there a fault output signal.

In general, the two Command inputs of a 50W Duo-Lase unit (CTRL1 and CTRL2) should always be driven identically with a “Y” or “T” connector. For special applications, such as redundant or ultra-wide dynamic range systems, it is permissible to drive only one Command input. Under this condition however, the random polarization beam quality will be compromised.

The optical combining technique is based on the fact that each laser is linearly polarized, allowing the use of a polarization sensitive beam combiner to achieve 98% efficiency in combining the two beams. The two components of the resulting beam are spatially parallel and collinear. Combining the output of two lasers reduces the normal temporal and spatial variations of a single laser. Output polarization is random and therefore superior for many cutting applications.

## Ch.2 Theory of Operation

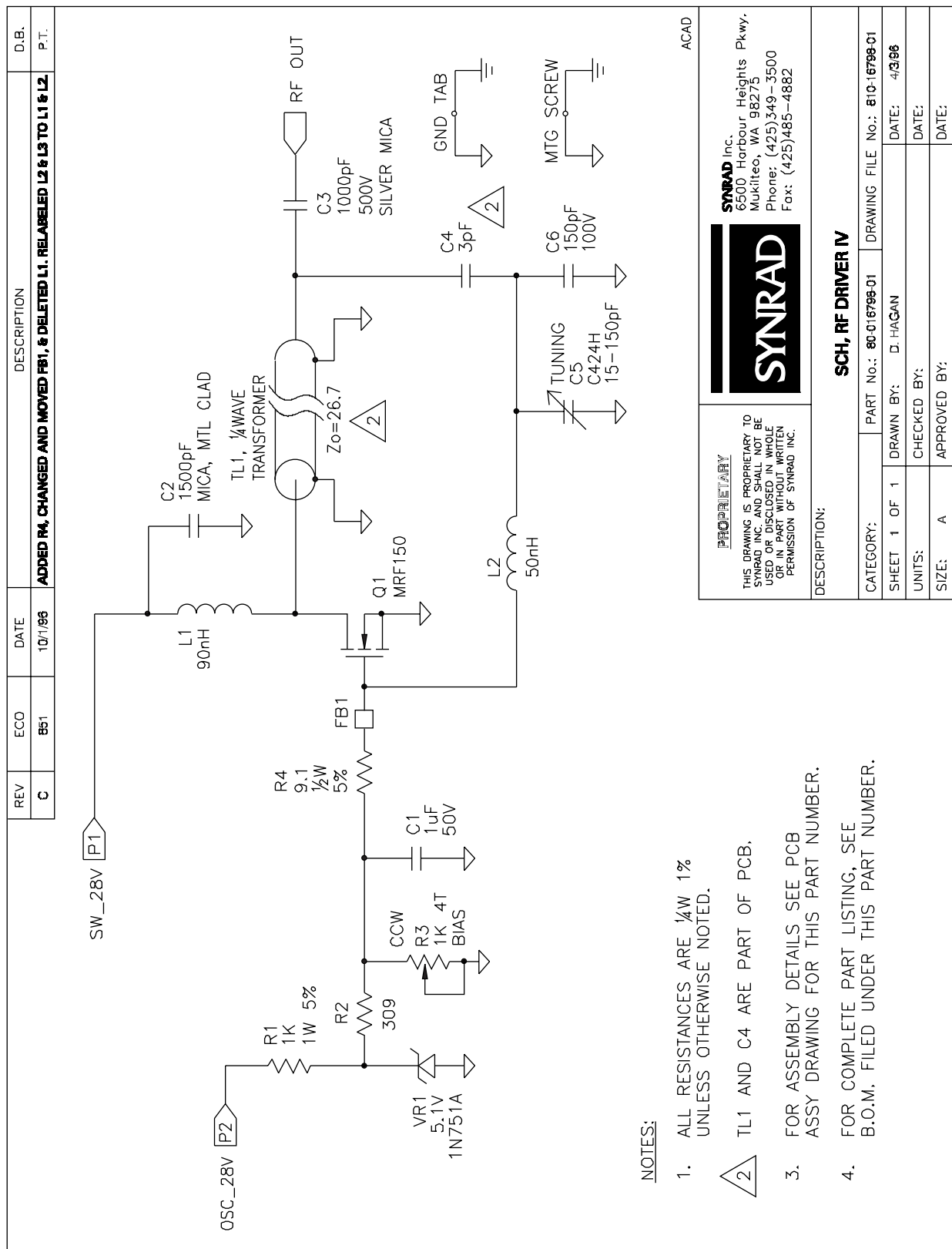

Figure 2.8 RF Driver IV

## Chapter 3 Physical Features

The physical features of the Series 48 lasers are shown in Figure 3.1 (48-1 and -2) and Figure 3.2 (48-5) and described in the following paragraphs.

### 3.1 Controls and Indicators

#### 3.1.1 Shutter Switch

The shutter switch is a mechanical shutter that closes the laser aperture. The shutter also actuates independent micro-switches that interrupt power to the laser section(s). The shutter should not be used to partially block the beam or to control output power. The shutter is standard on keyswitch versions and can be ordered, if necessary, for OEM versions.

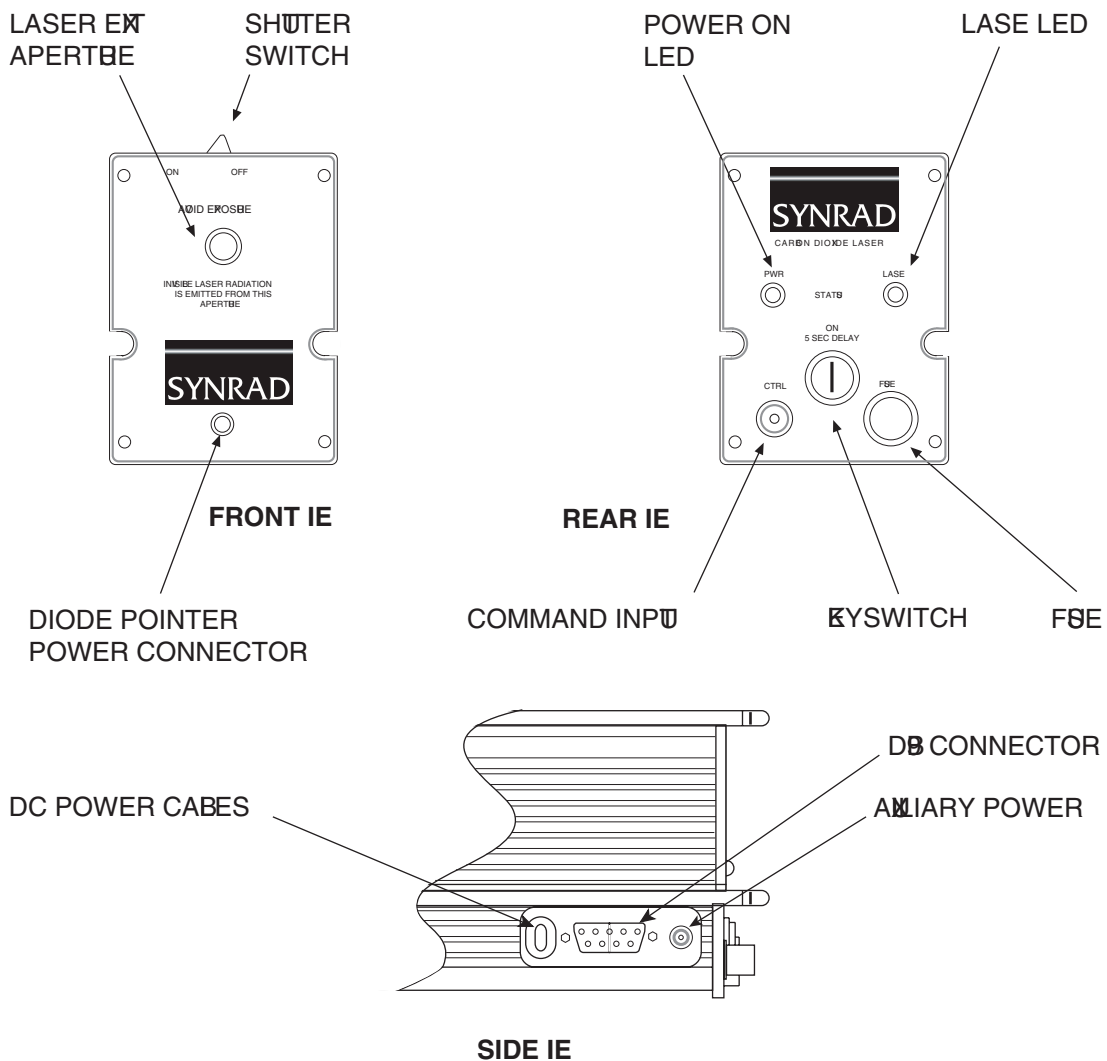
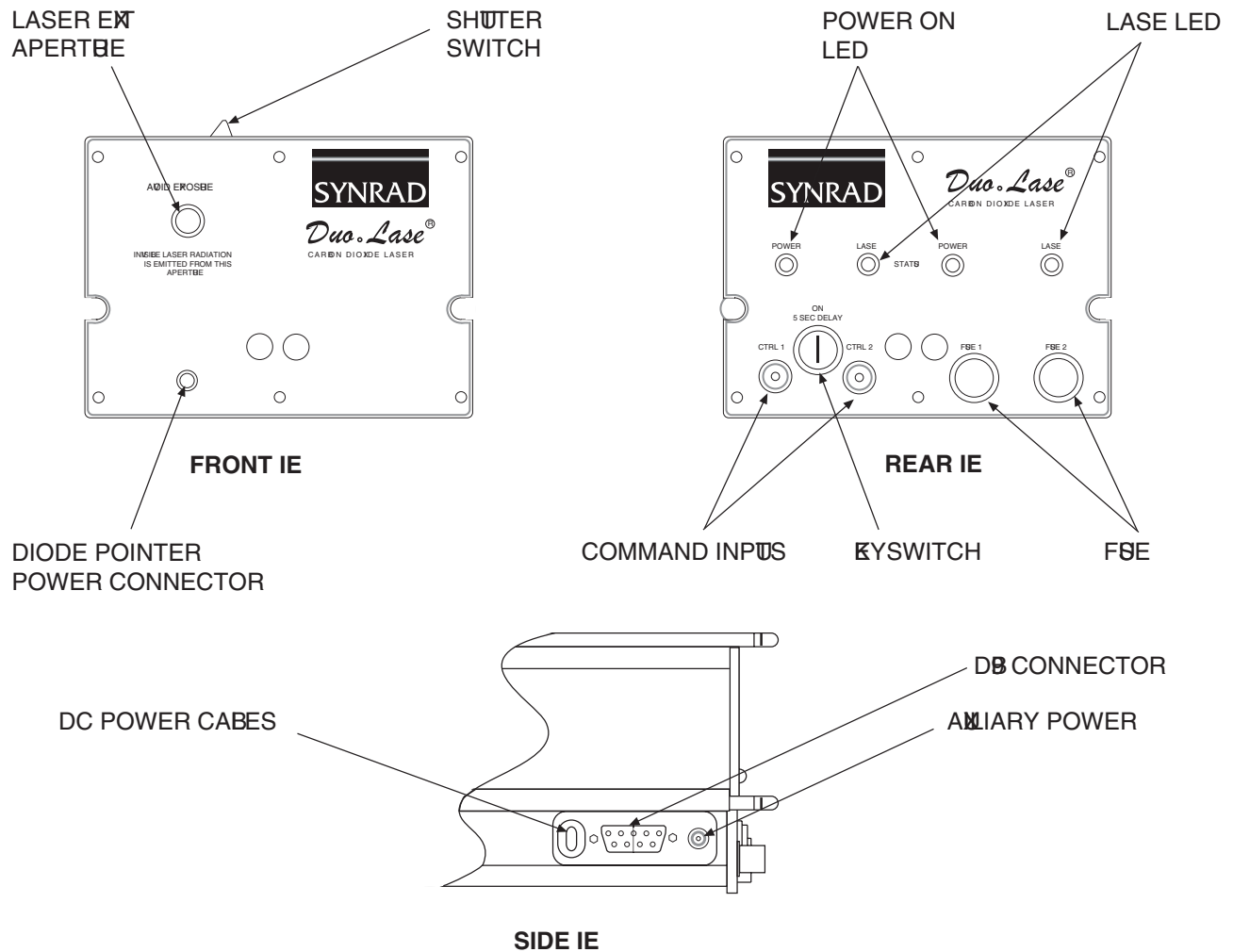

Figure 3.1 48-1, 48-2 Physical Features Location Diagram



**Figure 3.2 48-5 Physical Features Location Diagram**

### 3.1.2 Power On LED

The POWER LED is a panel mounted LED that illuminates green when the keyswitch is turned to the ON position which indicates that power is applied to internal circuitry. This LED is standard on both OEM and keyswitch versions.

### 3.1.3 Lase LED

The LASE LED is a panel mounted LED that illuminates red to indicate the Lase mode of operation. If a Command signal is present, the red LED turns on after the 5-second delay and becomes brighter as the Command duty cycle is increased. This LED is standard on both OEM and keyswitch versions.

### 3.1.4 Keyswitch

The panel mounted keyswitch is used to turn the laser on, off, and to reset faults. The key cannot be removed when the keyswitch is in the ON position. For OEM lasers, a plug is installed in place of the keyswitch and the keyswitch wires are shorted. The remote keyswitch pins of the DB9 connector then become the external power on/off control means.



### **3.1.5 Fuse**

The panel-mounted fuse(s) provides overcurrent protection for the internal circuitry of the laser. The required fuse is a fast blow type AGC/3AG rated at 32V minimum with the following current ratings:

48-1 10 Amp                      48-2 20 Amp                      48-5 20 Amp (2 Req'd)

### **3.1.6 DB9 Connector**

The DB9 connector is a 9-pin, female subminiature-D connector that provides for inter-connection of message, fault shutdown, remote interlock, remote keyswitch, and interface signals. Refer to Chapter 4 for detailed information on the use of the DB9 connector.

### **3.1.7 Command Input**

The CTRL connector is a BNC-style jack that accepts the Command input control signal. The output of the UC-1000 Controller is attached to this connector. For pure CW operation, a steady +5V signal can be applied through this connector. This input is optically-isolated from the chassis and power supply ground circuit but must not be subjected to common mode voltages greater than  $\pm 50V$  from chassis ground. The 48-5 laser has two Command inputs, CTRL1 and CTRL2, that should always be driven identically from the Controller by using a “Y” or “T” BNC connector.

### **3.1.8 DC Power Cables**

The red (+) and black (-) DC power input cables provide 30 VDC operating power to the laser. Standard length is 60 inches.

### **3.1.9 Auxiliary Power**

The Auxiliary Power connector is installed in the side panel of the laser housing and provides an optional 30 VDC @ 350 mA source for powering the UC-1000 Controller. An auto-resetting solid-state fuse limits line current. Connector power is active after 30 VDC is applied to the laser. The UC-1000 can also be powered from its 115 VAC wall transformer.

### **3.1.10 Laser Exit Aperture**

The laser aperture is the opening from which the laser beam is emitted when lasing. The beam shape is square at the laser output aperture, changing to circular at distances of approximately 1 meter or more from the laser. The laser beam diverges due to diffraction at a full angle of 4 milliradians, with the beam waist at the output aperture of the laser.

### **3.1.11 Diode Pointer Power Connector**

This connector is a regulated 5 VDC output capable of providing 100 mA for the optional Diode Pointer, available from SYNRAD. The output is internally protected against short circuits by an auto-resetting solid state fuse.

### **3.1.12 Mounting of Optical Accessories**

The front faceplates of Series 48 lasers are designed with a 6-hole mounting pattern (refer to the Outline/Mounting diagrams in Appendix A) to provide a convenient method for mounting standard beam delivery components available from SYNRAD. When considering other components not specifically designed as Series 48 options, please consult the factory for restrictions since excessive weight may cause damage to the laser.



## **Chapter 4**

# **Interface Requirements**

### **4.1 UC-1000 Universal Laser Controller**

Operation of Series 48 lasers requires an external controller that can provide the necessary Command input drive signal as the modulation source. The SYNRAD UC-1000 Controller has been designed to provide control of the laser from a remote source. The UC-1000 requires 24-32 VDC @ 200mA from its supplied wall plug transformer/rectifier or can be connected to the Auxiliary Power connector on the side panel of the laser via the power cable provided with the UC-1000. Refer to Appendix B for more information on the UC-1000 Controller.

### **4.2 DC Power Supply**

#### **4.2.1 48-1 / 48-2 Model**

SYNRAD power supplies, models DC-1 and DC-2, are sized to power 48-1 and 48-2 lasers, respectively. If substituting power supplies, use a well-regulated DC power supply in the range of 30 to 32V with no more than 3V overshoot under a 10-90% modulation load. Laser current is under 7 A for the 48-1 and 14A for the 48-2. The use of short leads is recommended. Please note that SYNRAD lasers are built and tested to meet published specifications at an input voltage of 30 VDC.

#### **4.2.2 48-5 Model**

The SYNRAD model DC-5 power supply is used to power the 48-5 laser. If substituting, use a well-regulated DC power supply in the range of 30 to 32V with no more than 3V overshoot under a 10-90% modulation load. The use of short leads is recommended and use of appropriate terminations rated for currents up to 28 A is recommended. Please note that SYNRAD lasers are built and tested to meet published specifications at an input voltage of 30 VDC.

### **4.3 DB9 Connector**

All 48 Series lasers are equipped with a female DB9 connector mounted to the sidewall of the laser. It provides the user with a convenient method for monitoring fault conditions (over-temperature, control/RF circuitry failure) and adds remote interlock, remote keyswitch (relay or switch), message output, and remote LED indicator capability. DB9 pin assignments and functions are described in Table 4.1.

As shipped, the laser will have a DB9 male jumper plug installed in the panel-mounted DB9 to allow normal operation of the laser. The DB9 jumper plug has a plastic cap that covers the internal pins. Two shorting jumpers (see Figure 4.1) are installed. One between pins 6 and 7 to close the remote keyswitch function, and one between pins 3 and 4 to close the remote interlock.

To take advantage of DB9 functions, you must manufacture a connecting cable and configure the connections for proper operation. A spare DB9 male connector and cover is included with each laser to facilitate easy cable manufacture.

## Ch.4 Interface Requirements

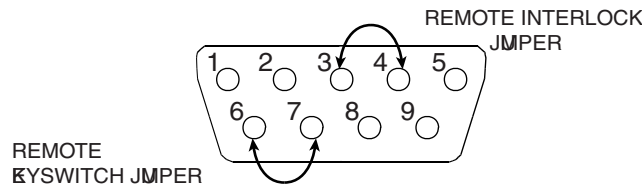

**Figure 4.1 DB9 Jumper Plug**

Table 4.1 DB9 Connector Pin Assignments

| PIN NO | SIGNAL NAME             | DESCRIPTION   | PURPOSE   |
|--------|-------------------------|---|---|
| 1      | FAULT SHUTDOWN          | Allen-Bradley (A-B) compatible output indicates failure of internal control/RF circuitry or existence of an overtemperature ( $> 60^{\circ}\text{C} \pm 2^{\circ}\text{C}$ ), overvoltage, or under-voltage condition. The active low signal transitions from +15V to 0V when a fault occurs. See notes 1, 5. | Provides user with control signal to disable external systems in the event of a fault.  |
| 2      | SIGNAL / CHASSIS GROUND | Signal ground for pins 1, 3, 5, 8, and 9.   |   |
| 3      | REMOTE INTERLOCK INPUT  | Disables the laser when opened by a remote door or housing safety interlock. As shipped, pins 3 and 4 are jumpered to disable the remote interlock function, allowing the laser to function normally.   | Allows an open external interlock switch to shut down the laser.  |
| 4      | SIGNAL / CHASSIS GROUND | Signal ground for pins 1, 3, 5, 8, and 9.   |   |
| 5      | MESSAGE OUTPUT          | A-B compatible output goes low when laser tube temperature reaches $54^{\circ}\text{C} \pm 2^{\circ}\text{C}$ and remains low until temperature falls $2^{\circ}\text{C}$ . See notes 1, 5.   | Provides user with a pre-shutdown temperature warning. Does not shut down the laser.  |
| 6      | REMOTE KEYSWITCH INPUT  | For connecting a remote relay or switch in series with the laser keyswitch. As shipped, pins 6 and 7 are jumpered to disable the remote keyswitch function allowing laser to function normally using the keyswitch for on/off control. See notes 2, 4.  | Allows user to control laser on/off /reset from a remote location. Connect to pin 7 to run; open to stop and/or reset faults. |
| 7      | REMOTE KEYSWITCH OUTPUT | See pin 6 description above. Pin is at DC line potential when the keyswitch is on or bypassed. See notes 2, 3.  | Allows user to control laser on/off /reset functions from a remote location.  |
| 8      | REMOTE LASE LED OUTPUT  | Current and voltage limited output for direct connection to LED or LED-input opto-isolator. See note 1.   | Allows user to connect a remote Lase LED indicator.   |
| 9      | REMOTE READY LED OUTPUT | Current and voltage limited output for direct connection to LED or LED-input opto-isolator. See note 1.   | Allows user to connect a remote Ready LED indicator.  |

- (1) Pins 1, 5, 8, and 9 can be directly connected to the anodes of LEDs or LED-input opto-isolators without external current limiting devices. Connect LED cathodes to pin 2 or 4. Current is limited internally to 20 mA, 3.3V max.
- (2) Connecting an LED to pins 6 or 7 to indicate keyswitch status requires an appropriate external current-limiting resistor.
- (3) The remote keyswitch output pin is not current-limited or fused.
- (4) “Dry-circuit” external switches are recommended since current into the debounced remote keyswitch input pin is negligible.
- (5) Allen-Bradley (A-B) compatible outputs (pins 1 and 5) are Active Low. Specifications: OFF: +15 VDC, 5mA into 3K $\Omega$ . ON: < 1 VDC, sinking 100mA.

## 4.4 Cooling Requirements

Series 48 electronics are mounted opposite the laser tube in the smaller section of the “H” bay and share the same cooling removal as the plasma tube. Typical efficiency of CO<sub>2</sub> laser plasma tubes operating in a TEM<sub>00</sub> mode is 10% to 12% (radiation out to RF power in). Conversion efficiency of DC electrical power to RF is about 60%. Off-the-shelf AC-to-DC switch mode supplies are typically 85% efficient. Since overall "wall plug" efficiency of these lasers is about 6% to 8%, a considerable amount of heat removal must occur even at the 10W and 25W output power level. The thermal transport design for cooling Series 48 lasers has been adapted to a wide variety of user applications and laser operating requirements.

### 4.4.1 48-1 / 48-2 Cooling

**CAUTION**

Condensation and water damage can occur if cooling water temperature is below the dew point.

Heat load for the 48-1 laser is 200 watts maximum and 400 watts maximum for the 48-2. In all but very low duty cycle applications, external cooling must be applied to the laser chassis; this may take the form of either forced air or water-cooling.

Air cooling is accomplished by placing four 4.69 inch fans at the side of the laser and directing air flow perpendicular to the laser cooling fins (refer to Figure 4.2). This method will produce sufficient cooling when operating at any duty cycle, including CW mode (100% duty cycle). Minimum delivery requirements for air-cooling are 500 cubic feet per minute (CFM) of free air for the 48-1 (2 fans @ 250 CFM per fan) and 1000 CFM for the 48-2 (4 fans @ 250 CFM per fan). Consult the factory for optimum design.

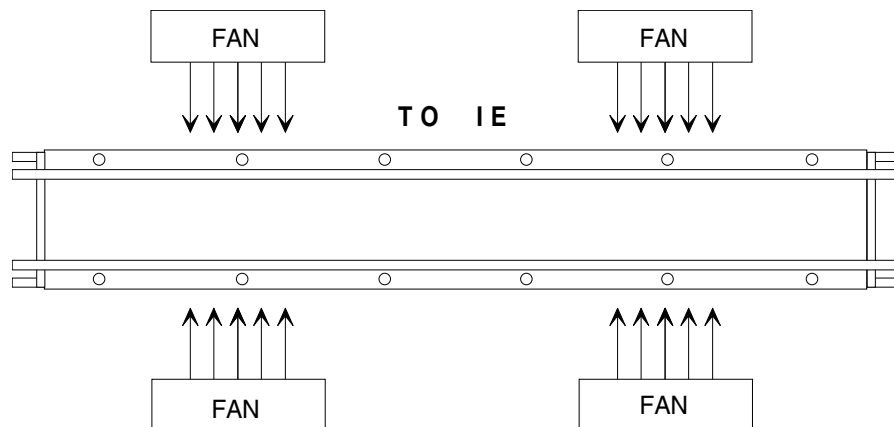

**Figure 4.2 48-2 (25W) Cooling Fan Placement**

## Ch.4 Interface Requirements

When using water-cooling, the recommended flow rate is 0.5 gallons per minute (GPM) for the 48-1 and 0.8 GPM for the 48-2 model at an inlet temperature of 18 to 20°C. Inlet cooling water temperature should always be maintained above the dew point to avoid condensation and water damage to the laser. Heat removal from the cooling water is required and can be accomplished using a chiller. Water-cooling is designed to provide sufficient cooling at up to 100% duty cycle.

Water enters at the laser's rear plate through the lower side-mounted 1/4 inch diameter cooling tubes and exits through the top mounted cooling tubes. Both circuits must be used in parallel to maintain thermal balance. A cooling intake and outlet manifold using a quick-disconnect fitting system (refer to Figure 4.3) is shipped as a kit with the laser. The two "U" shaped connections should be installed on the front plate. The quick-disconnect fittings can be removed from the tubing by compressing the front ring of the fitting against the body of the fitting. The cooling kit also includes quantities of both straight and elbow fittings. Other compatible fittings can be ordered from local fitting supply houses.

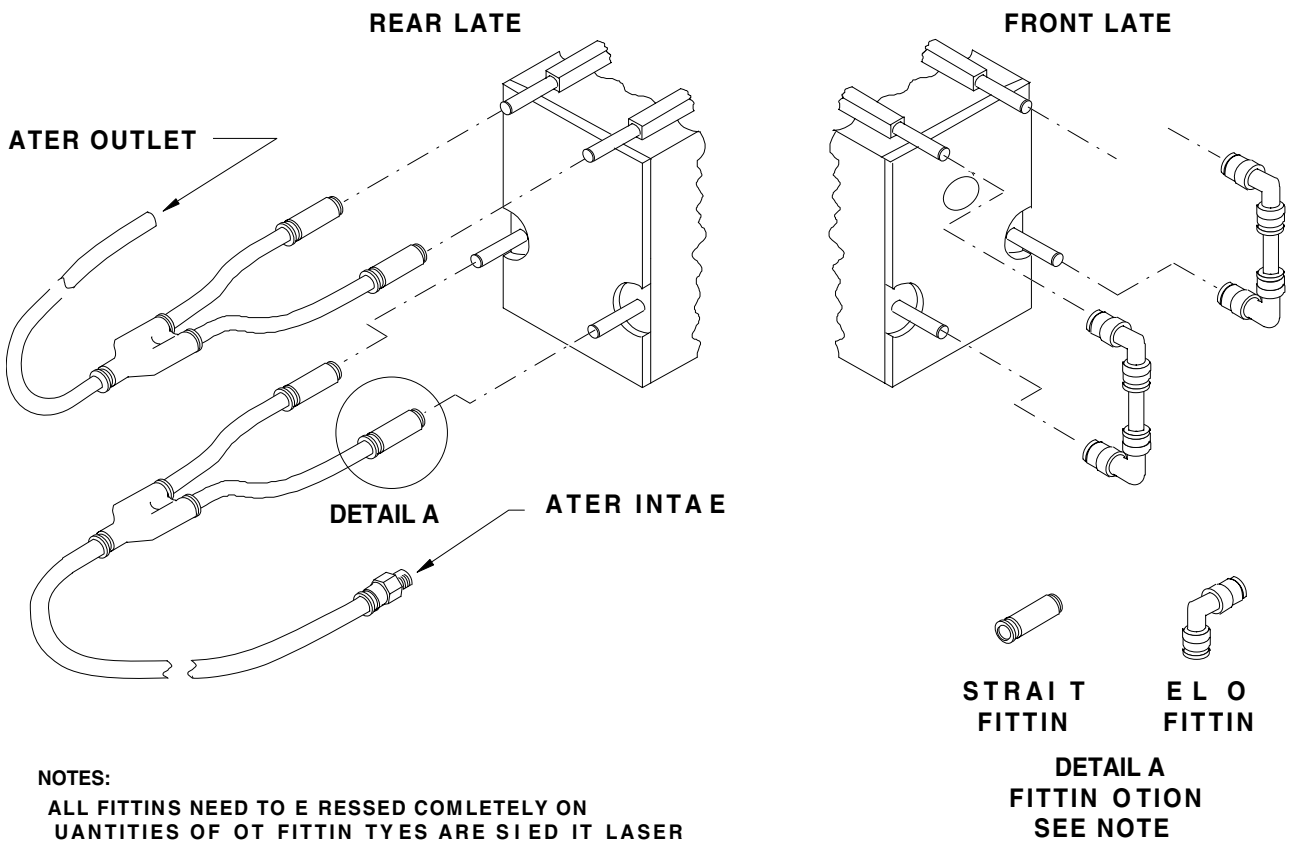

Figure 4.3 48-1 / 48-2 Laser Cooling Kit

**4.4.2 48-5 Cooling**

The 48-5 heat load is 800 watts maximum and requires water-cooling to prevent damage to the laser. Cooling water between 18 and 20°C maximum at a minimum flow rate of 1.5 GPM must be used. Inlet cooling water temperature should always be maintained above the dew point to avoid condensation and water damage to the laser. Heat removal from the cooling water is required and can be accomplished using a chiller.

The cooling water intake is through the lower side-mounted tubes plus one central tube located on the rear plate of the laser. Exit is from the two top tubes and one of the central tubes also on the rear plate. The front central tubes are "jumpered" using a U-fitting, while the front side and top are also jumpered at each side using two right angle fittings (refer to Figure 4.4).

A cooling intake and outlet manifold using a quick-disconnect fitting system is shipped as a kit with the laser. The quick-disconnect fittings can be removed from the tubing by compressing the front ring of the fitting against the body of the fitting. The cooling kit also includes quantities of both straight and elbow fittings. Other fittings can be ordered from local fitting supply houses.

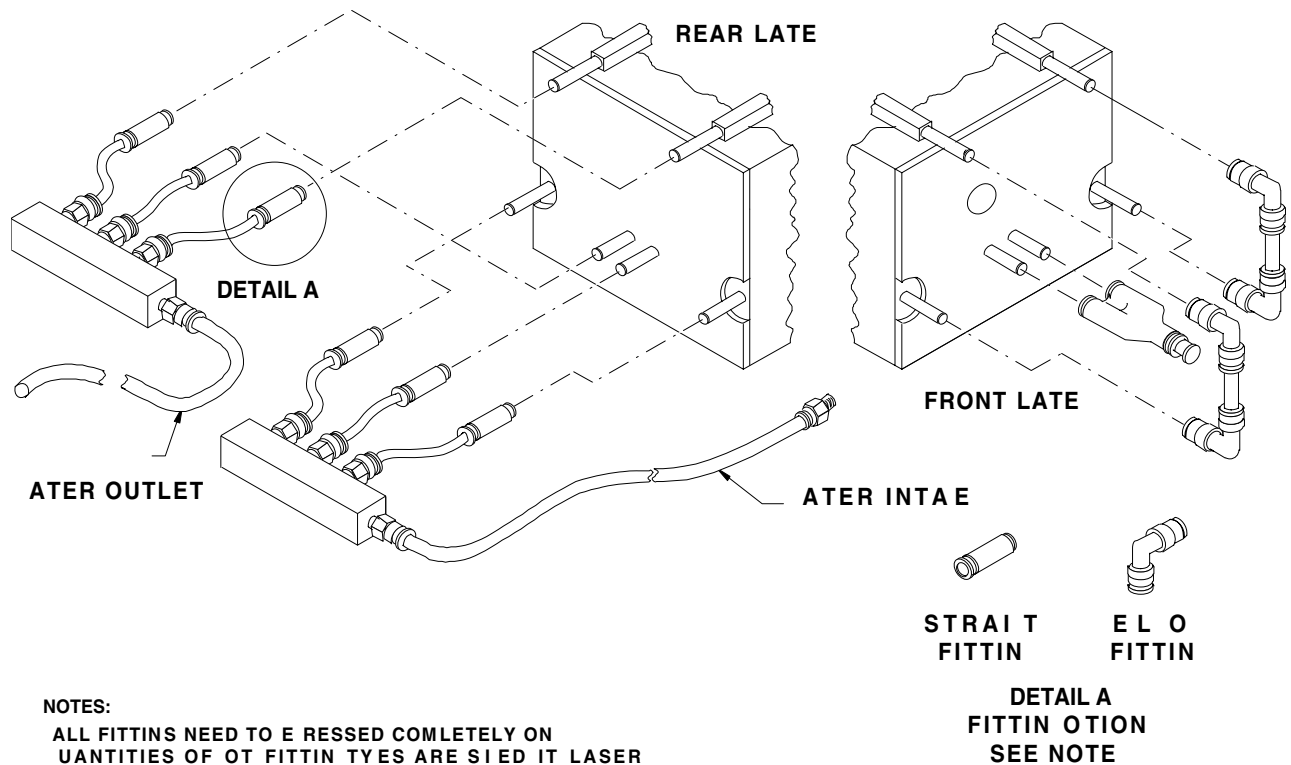

**Figure 4.4 48-5 Laser Cooling Kit**





## **Chapter 5 Unpacking and Setup**

### **5.1 Unpacking/Initial Inspection**

Place the shipping container on a sturdy, level surface and open the top of the box. Verify that the following items are included in the container:

- Series 48 Laser
- Operation and Service Manual
- Spare Fuse(s): One 10 Amp (48-1)
  - One 20 Amp (48-2)
  - Two 20 Amp (48-5)
- DB9 Connector
- DB9 Cover Kit
- Cooling Kit
- Warranty Registration Card
- Final Test Data Report

Carefully remove the Series 48 Laser from the container and remove the outer foam packing material.

**Do not discard the shipping container or the foam packing since these are required if the laser is ever returned to SYNRAD or a SYNRAD Authorized Service Center.**

Inspect the laser housing for any visible signs of shipping damage. Verify that all external labels are attached to the housing (refer to Appendix A for label location diagrams). Contact SYNRAD if the laser housing is damaged or if any of the required materials or labels are missing.

### **5.2 Mounting**

The recommended mounting orientation for Series 48 lasers is horizontal. If this cannot be accomplished, the lasers may be mounted at an angle of  $>20^\circ$  to the vertical. Consult the factory for limitations if the laser is to be mounted in a vertical orientation.

The laser may be hard-mounted to equipment by removing several of the bottom panel screws and replacing these with longer ones to secure the laser to optical assemblies. Use a minimum of 4 screws (Model 48-1) or 6 screws (Model 48-2/48-5) in a symmetrical pattern to properly distribute mounting forces. Do not remove the cover. This mounting method is only recommended as long as the screws do not support the weight of the laser. For a sturdier attachment, the laser may be clamped to optical assemblies by applying clamping forces between top and bottom cover screws. Do not apply clamping forces on the longitudinal centerline. Refer to Appendix A (Pages A5 - A7) for the appropriate outline/mounting diagram.

### **5.3 System Interconnections**

#### **5.3.1 48-1 / 48-2 Interconnections**

Note: Refer to Figure 5.1 for an illustration of a typical system interconnection.

1. Make coolant connections to the laser as described in Section 4.4.1.
2. Connect the red power cable to the positive (+) terminal on the DC power supply.  
Connect the black power cable to the negative (-) terminal on the DC power supply.

Note: If using a SYNRAD DC-1 or DC-2 Power Supply, verify that the input power jumpers are properly configured. The DC-1 is preset for 110 VAC input power. Refer to the power supply documentation to configure the input voltage for 220 VAC.

The default input voltage for the DC-2 Power Supply is 230 VAC. You must jumper terminals 1 and 2 on the input power terminal strip for 115 VAC input. Refer to the documentation provided with the power supply for additional wiring information.

3. Make interconnections between your electronic control equipment and the laser's DB9 connector as required.
4. Attach the UC-1000 Controller's power cable between the UC-1000's PWR 24 VDC jack and the laser's Auxiliary Power connector. The UC-1000 can also be powered from a wall plug by using the supplied wall plug transformer.
5. Attach the BNC control cable between the UC-1000's OUTPUT connector and the laser's CTRL connector.
6. If your application uses external gating signals to command on/off switching of the laser, attach a BNC cable between your Gate signal source (such as a computer or PLC) and the UC-1000's GATE connector.
7. If your application uses external analog voltage or current signals to control PWM, attach a BNC cable between your analog voltage or current source (typically a computer or PLC) and the UC-1000's ANV/C connector.

#### **5.3.2 48-5 Interconnections**

1. Make coolant connections to the laser as described in Section 4.4.2.
2. Connect the red power cable to the positive (+) terminal on the DC power supply.  
Connect the black power cable to the negative (-) terminal on the DC power supply.

Note: If using a SYNRAD DC-5 Power Supply, verify that the input power jumper is properly configured. The DC-5 is preset for 230 VAC input power. You must jumper terminals 1 and 2 on the input power terminal strip for 115 VAC input. Refer to the documentation provided with the power supply for additional wiring information.

3. Make interconnections between your electronic control equipment and the laser's DB9 connector as required.

4. Attach the UC-1000 Controller's power cable between the UC-1000's PWR 24 VDC jack and the laser's Auxiliary Power connector. The UC-1000 can also be powered from a wall plug by using the supplied wall plug transformer.
5. Attach the long "leg" of the BNC "Y" control cable to the UC-1000's OUTPUT connector. Attach the short "legs" of the "Y" connector to the laser's CTRL 1 and CTRL 2 connectors.
6. If your application uses external gating signals to command on/off switching of the laser, attach a BNC cable between your Gate signal source (such as a computer or PLC) and the UC-1000's GATE connector.
7. If your application uses external analog voltage or current signals to control PWM, attach a BNC cable between your analog voltage or current source (typically a computer or PLC) and the UC-1000's ANV/C connector.

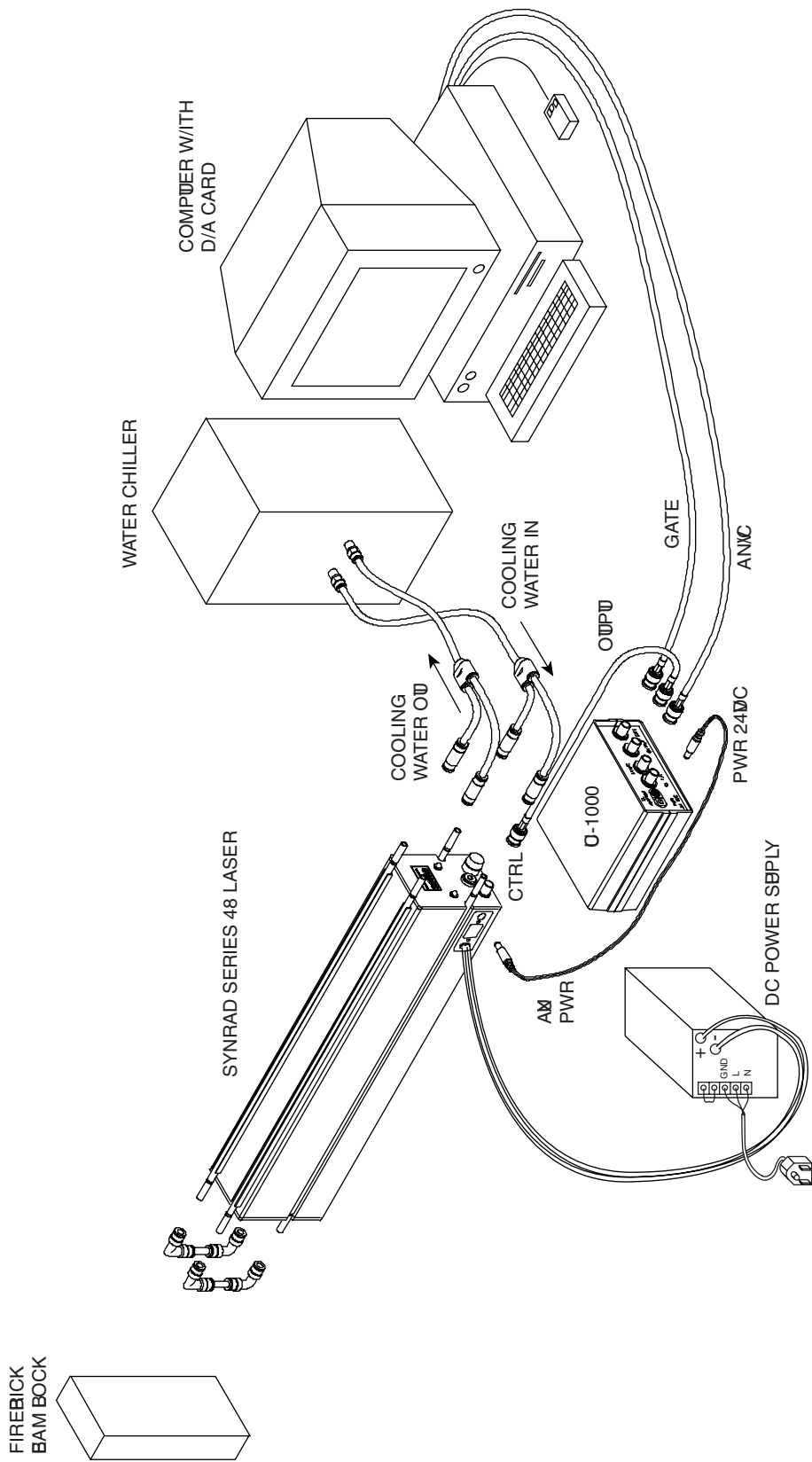

**Figure 5.1 Typical System Interconnection Diagram**

## Chapter 6 Operating Instructions

### 6.1 General

The operating instructions provided in this section are based on the use of a SYNRAD UC-1000 Universal Laser Controller. If using an alternate method of laser control, please consult the factory for information regarding key aspects of laser operation.

### 6.2 Turn-On/Check-Out

#### **CAUTION**

These RF Excited Lasers must be provided with a pre-ionizing “Tickle” signal during standby or laser “low” periods. This is automatically provided with SYNRAD’s UC-1000 Power Controller. This signal keeps the plasma ionized during laser “low” periods and facilitates breakdown and pulse to pulse fidelity. Damage or malfunction may occur if this or equivalent drive signals are not used.

#### **WARNING**

**Harmful laser radiation is emitted through the laser exit aperture when performing the following procedure.**

1. Confirm the DB9 jumper configuration required for your application (refer to Section 4.3).
2. Verify that the external DC power supply, UC-1000, laser keyswitch, and laser shutter are all set to OFF.
3. Verify that all electrical and cooling interconnections have been accomplished according to Section 5.3. Turn on the cooling system. If using cooling water, examine all connections for leaks.
4. Ensure that all personnel in the area are wearing protective eyewear.
5. Place a beam block in front of the exit aperture.
6. Apply power to the external DC power supply.
7. Set the UC-1000 mode switch to MAN (manual mode). Set the UC-1000 POWER ADJ control to MIN and set UC-1000 POWER switch to ON. Verify the red power ON LED on the front panel of the UC-1000 illuminates.
8. Set the mechanical shutter on the laser to the ON (open) position.
9. Turn the laser’s keyswitch to ON and/or close the remote keyswitch. Verify that the green POWER LED on the Laser Head illuminates.
10. Verify that the red LASE LED on the laser illuminates (dimly) after approximately 5 seconds. This indicates tickle pulses are being applied to the laser.

11. Slowly rotate the UC-1000 POWER ADJ control towards MAX and verify that the intensity of the red LASE LED on the laser increases as the UC-1000 output is increased.
12. While the UC-1000 is set for maximum power output, measure laser output using a laser power meter (such as SYNRAD's PW-250 Power Wizard) to verify that the output is consistent with the power rating for your respective laser model (refer to Table 2.1 for power specifications).
13. Reduce power output to minimum, then turn off laser power (set keyswitch to OFF or open remote keyswitch circuit as appropriate).
14. Set the mechanical shutter and UC-1000 power switch to OFF. Turn off external DC power supply.

### **6.3 Operation in Pulsed Mode**

In applications such as marking and cutting, the laser is required to pulse on and off in synchronization with an external pulsing control signal (typically from a computer or function generator operating in the range from 0 to 1 kHz). To operate the laser in pulsed mode, perform the following procedure:

1. Perform Section 6.2, Steps 1 through 6.
2. Set the UC-1000 mode switch to MAN (manual mode).
3. Adjust the UC-1000 front panel POWER ADJ control to the desired power level. (If a duty cycle of 100% is required, consult factory for modification instructions).
4. Connect the pulsing control signal to the GATE input connector on the rear panel of the UC-1000.
5. Set the mechanical shutter on the laser to the ON (open) position.
6. Turn the laser's keyswitch to ON and/or close the remote keyswitch. Verify that the green POWER LED on the Laser Head illuminates.
7. Verify that the red LASE LED on the laser illuminates (dimly) after approximately 5 seconds. This indicates tickle pulses are being applied to the laser.
8. The laser system is now configured to operate in the pulsed mode. When the Gate input pulses high (> 3.5 VDC), the UC-1000 will turn on the laser at a power level corresponding to the UC-1000 POWER ADJ switch setting. When the Gate input goes low (< 0.5 VDC), the UC-1000 terminates lasing and reverts to standby mode (tickle pulse only).

## 6.4 Operation in Continuous Wave (CW) Mode

In some applications, such as high speed marking, the finite turn off time of the laser due to modulation causes a series of dots that may be visible on the marking surface instead of a “clean” line. Operating the laser in CW mode will prevent this from occurring; however there will be a slight decrease in laser efficiency when the duty cycle is increased beyond 95% (refer to

Figure 2.1). To operate the laser in CW mode, a constant +5 VDC signal can be connected to the Command input of the laser. This constant source will force the internal switching electronics to remain on, providing continuous and uninterrupted laser output power. Note that in CW mode, laser power output cannot be adjusted using the UC-1000. If laser power needs to be adjusted, refer to Section 2.4.2 for information regarding high frequency operation. A tickle signal must still be provided to the laser during standby periods if fast beam response is important.

The UC-1000 can be modified to achieve 100% duty cycle operation if required for your application. Consult the factory for requirements and details.

## 6.5 PC Control of Laser

To control on/off pulsing of the laser (pulsed mode), a signal providing TTL-level pulses is connected to the GATE input connector on the rear panel of the UC-1000. Typically, this signal would be generated using an add-in digital I/O card and controlling software. **On the standard UC-1000, the gate input is set to internal pull-up (normally on) mode. A TTL high input signal or an open (disconnected) gate connector will cause the beam to turn on. To gate the beam off, a logic low input or short circuit must be applied to the GATE input connector.** UC-1000X (Mod-X) controllers have the gate input set to internal pull-down (normally off) mode. This prevents the beam from being enabled unless a TTL logic high (+3.5 to 5V) signal is applied to the GATE input connector. In the pull-down (normally off) mode an asserted logic low state, short circuit to ground, or an open or disconnected GATE input locks the beam off. Contact SYNRAD or see the UC-1000 Operation Manual for information on changing the UC-1000’s gate input mode for your application. If your UC-1000 does not have an internal pull-up/pull-down selector switch, contact SYNRAD for a free plug-in upgrade module.

If the user wishes to control laser power using a computer, either an analog voltage or an analog current can be connected to the UC-1000 ANV/C BNC input connector. To generate the analog voltage, a digital-to-analog (D/A or DAC) card capable of generating 0V (laser off) to 10V (maximum power) must be installed. To generate the analog current, a D/A card capable of generating 4mA (laser off) to 20mA (maximum power) must be installed. Controlling software is required for either analog voltage or analog current operation.

ANV or ANC control of the laser is not a linear transfer function. For example, a 12 mA ANC or 5V ANV input does not necessarily generate a 50% power level. The general curve is similar to that shown in Figure 2.1. A more precise definition of the curve can only be obtained experimentally on an individual basis.





## Chapter 7 Maintenance and Troubleshooting

**Table 7.1 Series 48 Troubleshooting Table**

| FAULT  | PROBABLE CAUSE   |
|--|--|
| Laser beam is off.   | <ol style="list-style-type: none"> <li>1. Check power source, keyswitch, and aperture shutter to verify that they are properly set. Allow for the built-in five-second delay between turning on electrical power and initiation of laser excitation.</li> <li>2. Check for the presence of a remote keyswitch, remote interlock, or the factory installed DB9 jumper.</li> <li>3. Check fuses and supply voltages.</li> <li>4. If the laser is warm, allow it to cool and cycle the source power to see if the thermal cutout was activated.</li> <li>5. Check for proper Command input signal. The laser will not operate unless an input signal to the CTRL jack is present.</li> <li>6. Return keyswitch to the OFF position for a few seconds, or cycle source power to reset circuits.</li> <li>7. If the laser still will not start, factory authorized servicing of the laser may be required.</li> </ol> |
| Laser power is low.  | <ol style="list-style-type: none"> <li>1. Check waveform of Command input signal if modulation is used.</li> <li>2. Check input voltage level (30 VDC minimum).</li> <li>3. Use mode screen (ceramic tile can be used) to verify circular optical beam shape at a distance of 3 to 5 feet from the laser. If beam spot is not circular and stable, the optical mirror alignment is out of adjustment. See below.</li> <li>4. If laser power is below specification, laser gas may need to be replaced, or one of the RF drivers is defective. Contact a factory authorized service center.</li> </ol>  |
| Laser spot is not circular or does not stay circular.              | <ol style="list-style-type: none"> <li>1. Check for proper air or water coolant flow.</li> <li>2. The optical mirrors are adjusted at the factory to give a TEM<sub>00</sub> output beam that is circular 3 feet or more from the output aperture. Severe mechanical forces on the chassis may shift the original alignment of the mirrors temporarily or permanently. Contact a factory authorized service center.</li> </ol>   |
| Laser power varies or is intermittent in response to input pulses. | <ol style="list-style-type: none"> <li>1. Verify that the UC-1000 Controller or equivalent has "tickle" pulses of proper duration. (Refer to Section 2.4.1).</li> </ol>  |



## **Chapter 8**

# **Return for Factory Service**

In the event your Series 48 Laser requires return for factory service, SYNRAD must be contacted prior to shipment of the laser for a Return Authorization (RA) number. The Return Authorization number must be included on all shipping documentation included with the returned laser. The following information is required by SYNRAD to issue a Return Authorization number:

- Name of company
- Name and phone number of individual requesting return of the laser
- Model number
- Serial number
- Detailed description of the fault

Return the laser in the original packing material and shipping container. Write the Return Authorization number on the outside of the shipping container.

**SERVICE REQUEST**

Company Name \_\_\_\_\_

Contact Name \_\_\_\_\_

Company Address \_\_\_\_\_

Telephone # \_\_\_\_\_ Fax # \_\_\_\_\_

Date originally received \_\_\_\_\_

Date returned \_\_\_\_\_

RA# \_\_\_\_\_

Serial# \_\_\_\_\_

Describe reason for repair \_\_\_\_\_

\_\_\_\_\_  
\_\_\_\_\_  
\_\_\_\_\_  
\_\_\_\_\_  
\_\_\_\_\_  
\_\_\_\_\_  
\_\_\_\_\_  
\_\_\_\_\_  
\_\_\_\_\_  
\_\_\_\_\_  
\_\_\_\_\_  
\_\_\_\_\_

Should you need to return a laser for repair, please contact SYNRAD Customer Service to obtain an Return Authorization Number (RA #). In the U.S. call: 1-800-SYNRAD1, outside the United States dial 425-349-3500 or fax your request to 425-485-4882

## **Appendix A Supporting Documentation**

### **List of Supporting Documentation**

| <u>Figure/Table Title</u>                           | <u>Page</u> |
|---|-------------|
| 48-1 Label Location Diagram .....                   | A-42        |
| 48-2 Label Location Diagram .....                   | A-43        |
| 48-5 Label Location Diagram .....                   | A-44        |
| 48-1 Outline/Mounting Diagram.....                  | A-45        |
| 48-2 Outline/Mounting Diagram.....                  | A-46        |
| 48-5 Outline/Mounting Diagram.....                  | A-47        |
| Interconnect Schematic, Model 48 Series Lasers..... | A-48        |
| Schematic, J Series Control Board.....              | A-49        |

# Appendix A Supporting Documentation

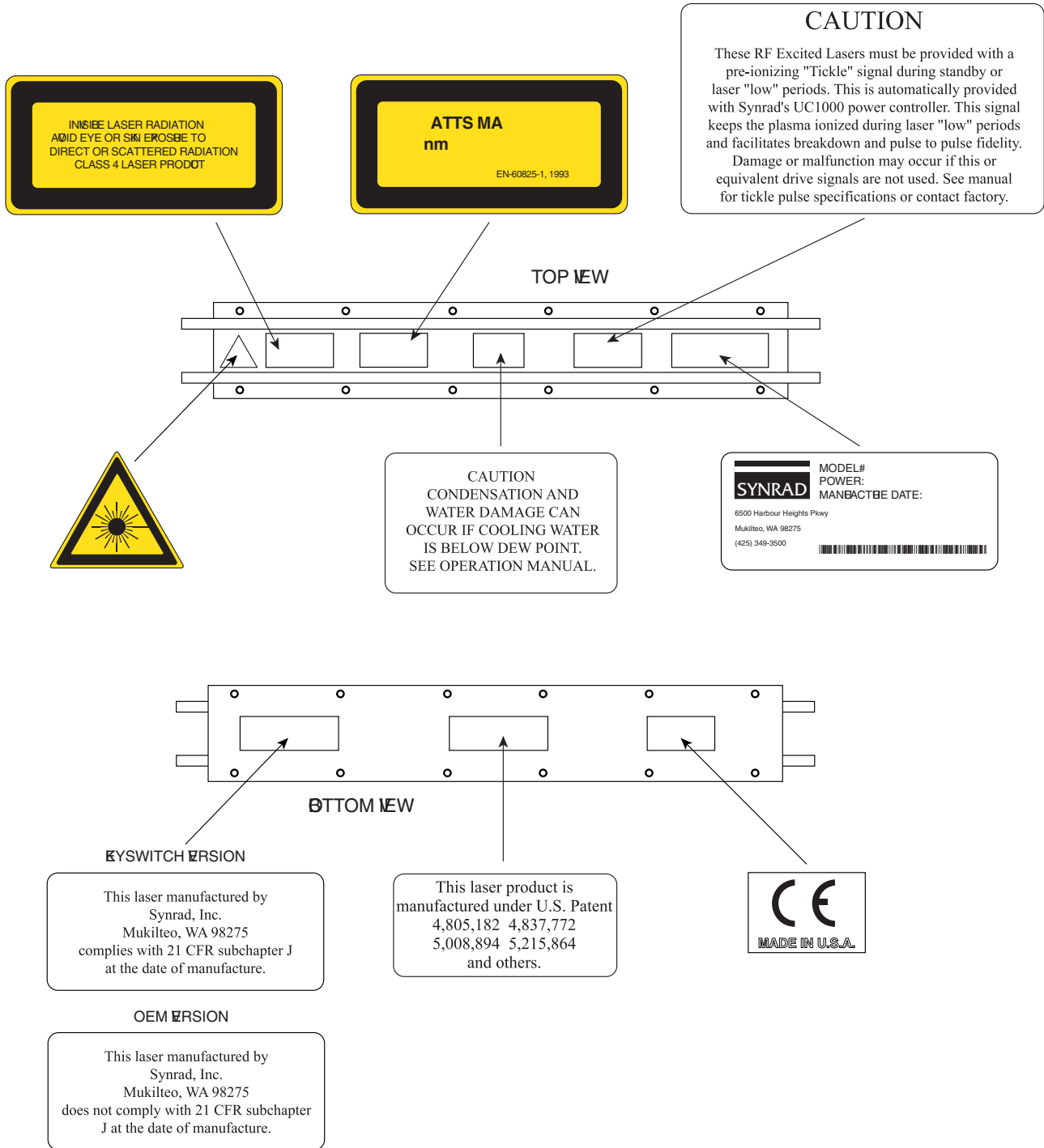

**48-1 Label Location Diagram**

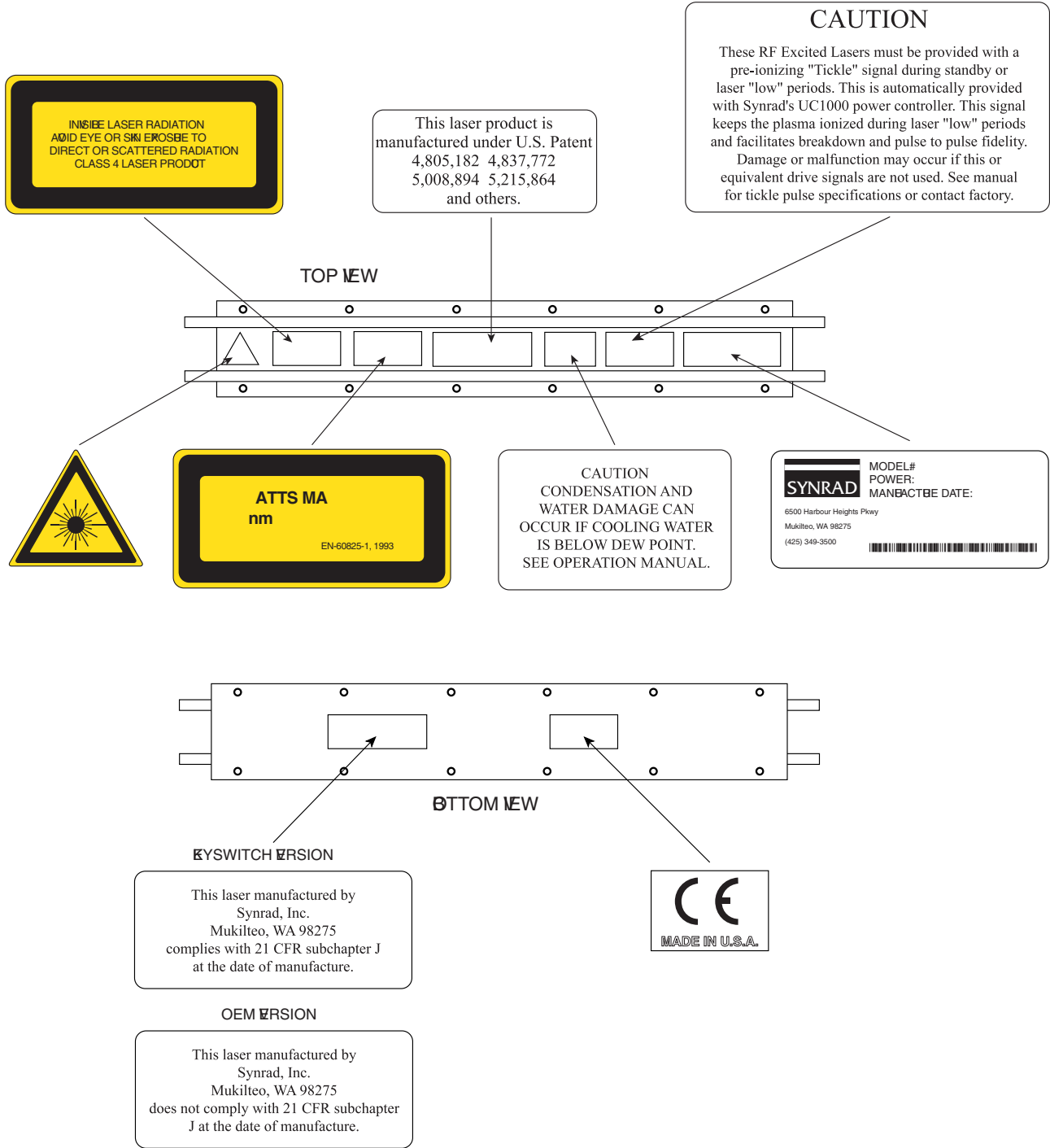

48-2 Label Location Diagram

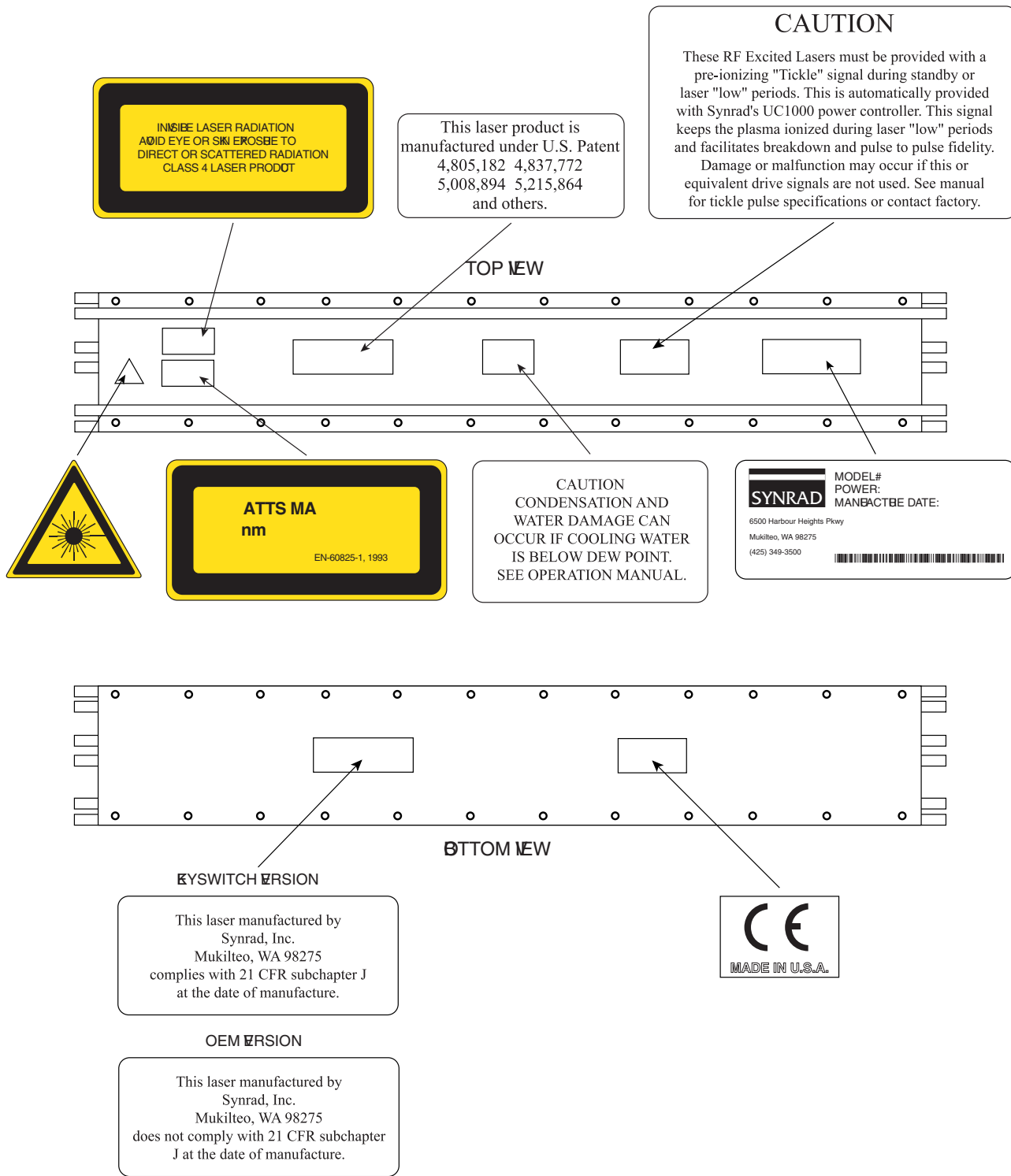

**48-5 Label Location Diagram**



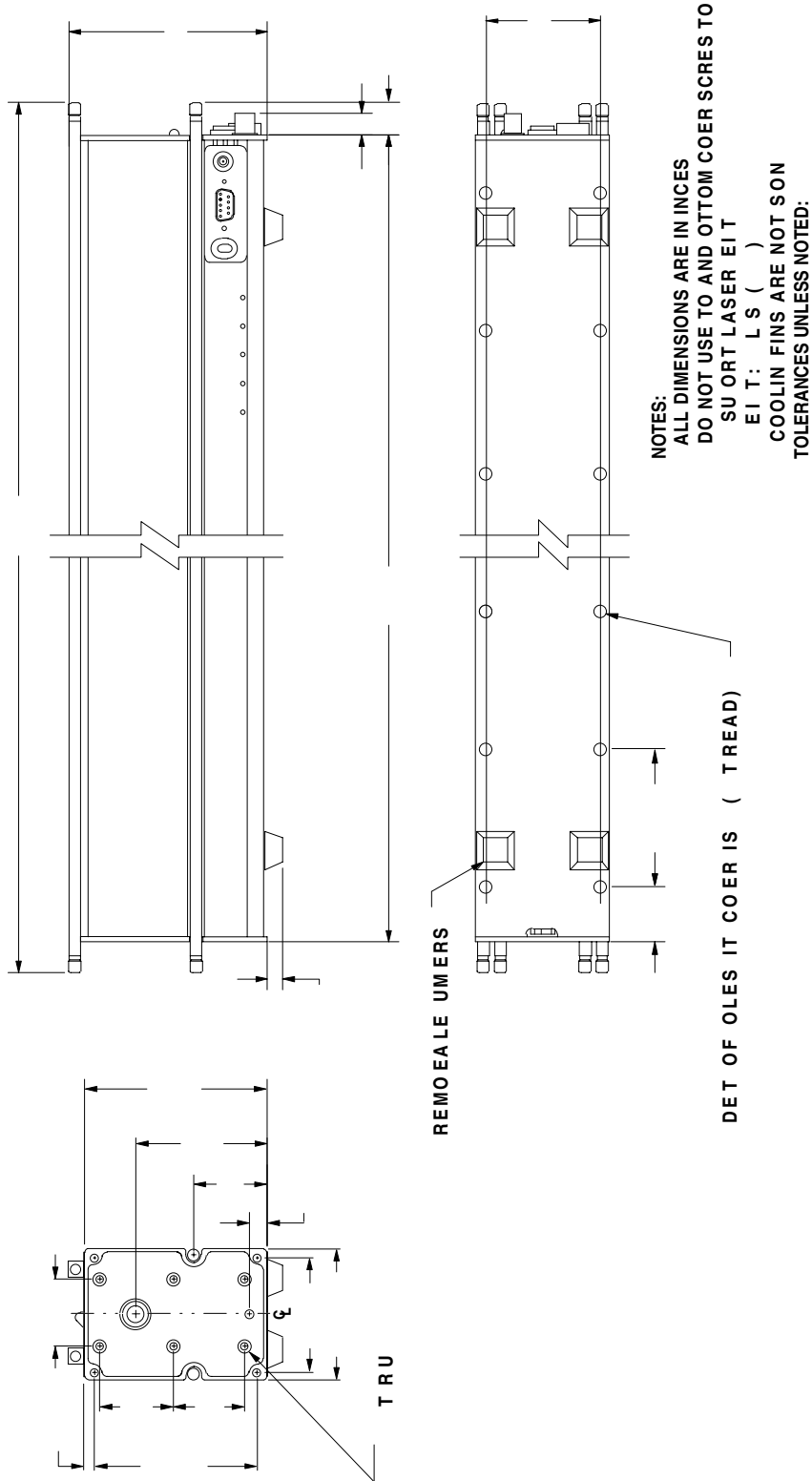

48-1 Outline/Mounting Diagram

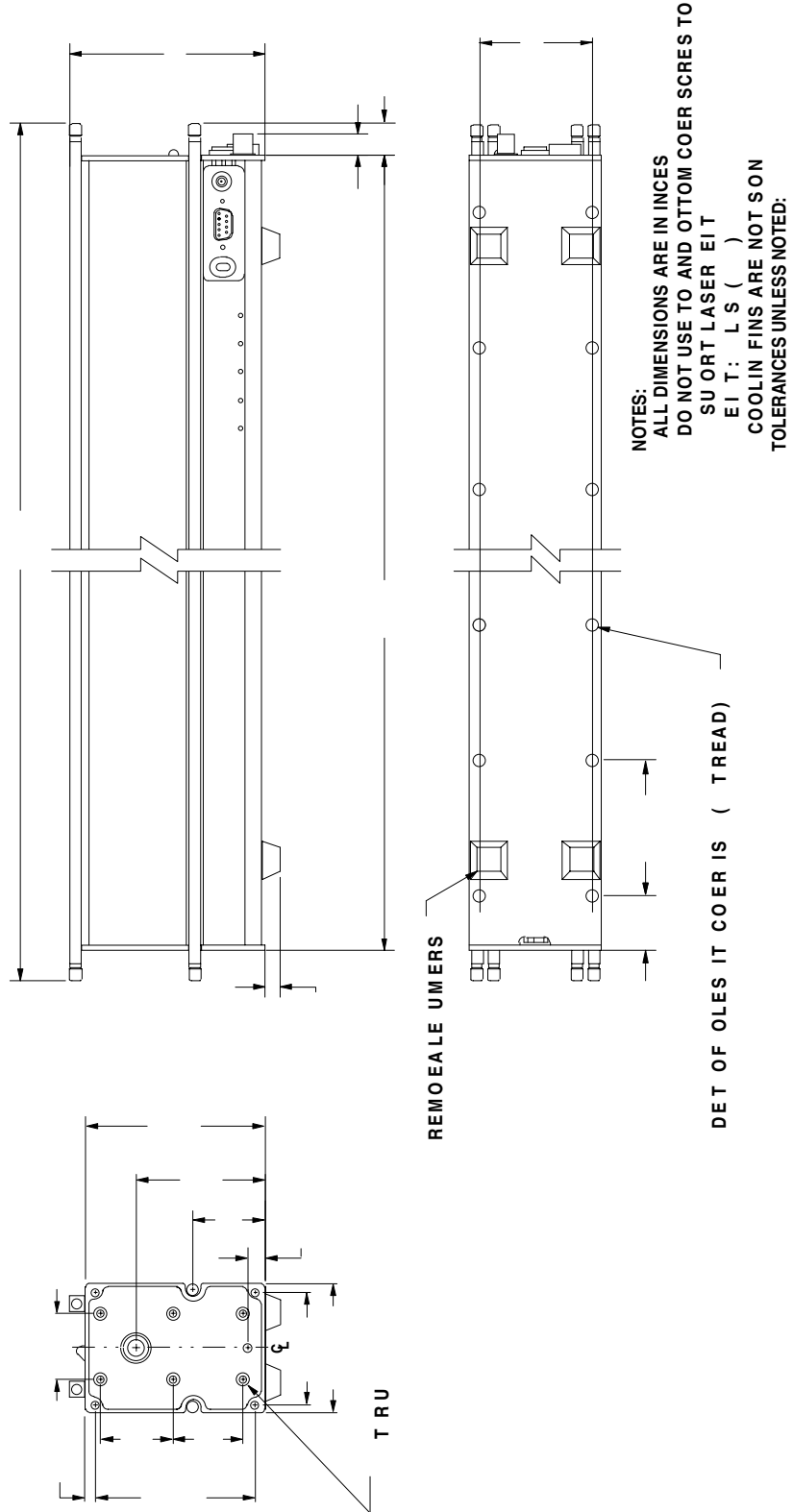

**48-2 Outline/Mounting Diagram**

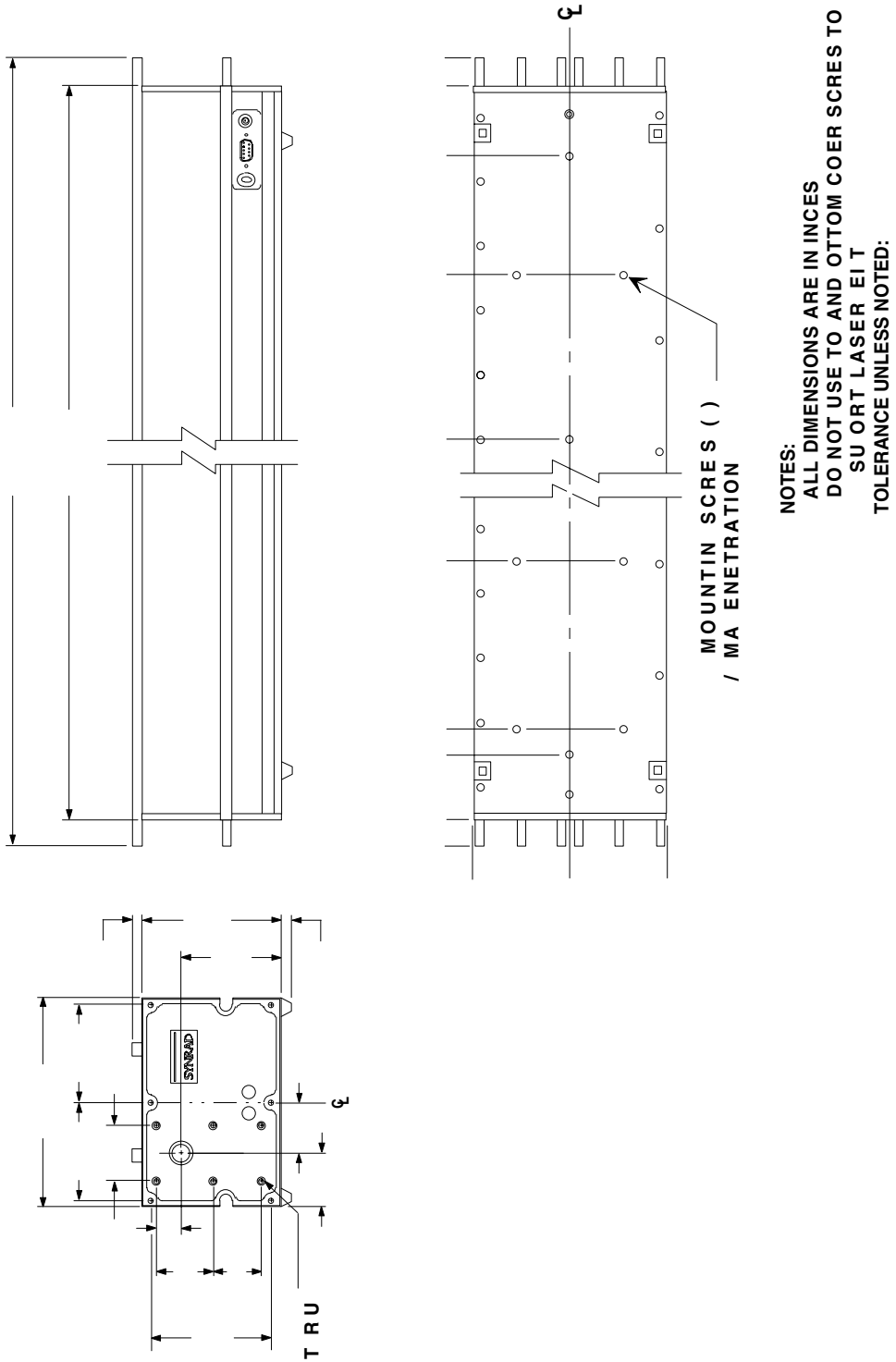

48-5 Outline/Mounting Diagram

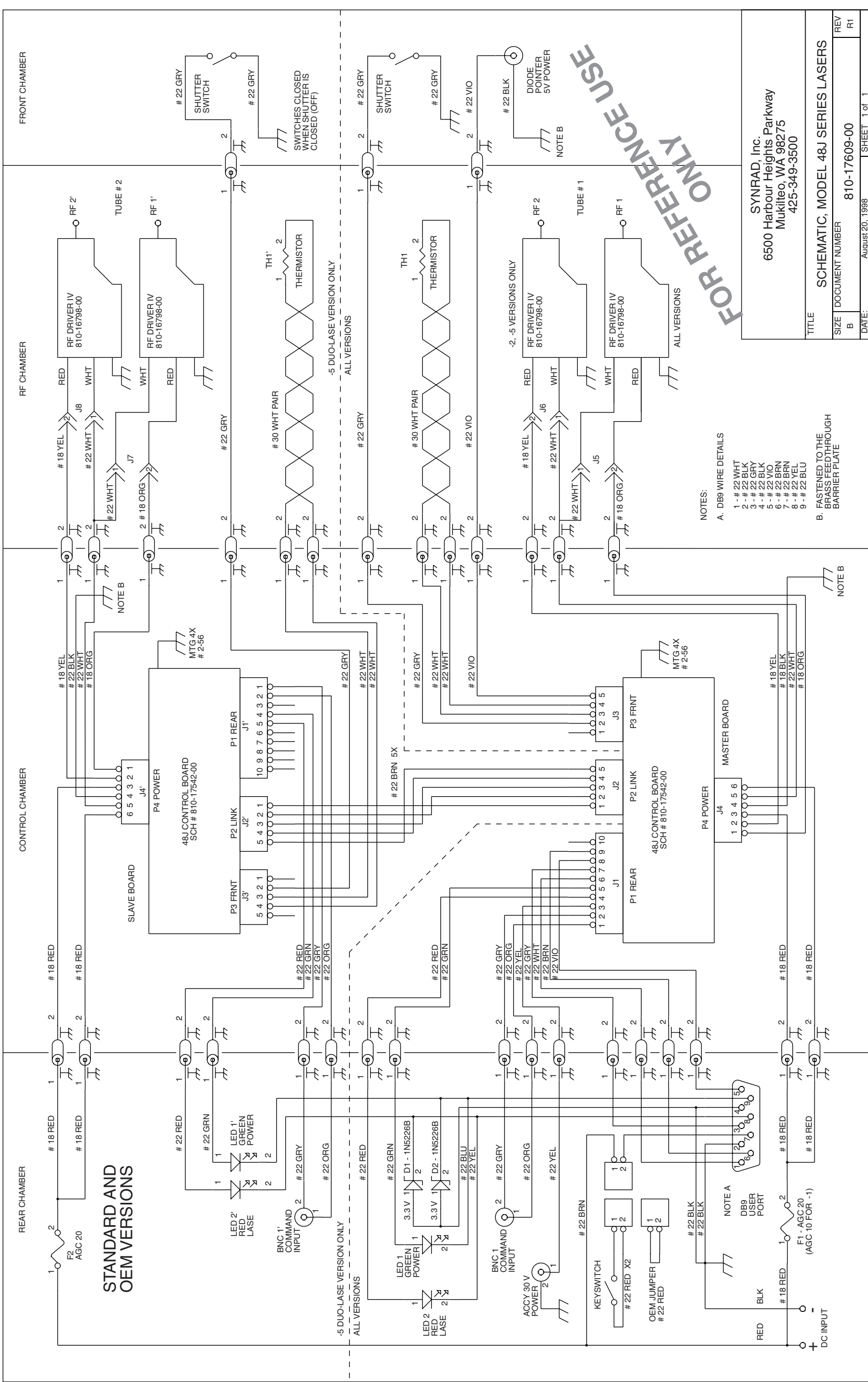

|  |                                    |
|--|------------------------------------|
| SYNRAD, Inc.<br>6500 Harbour Heights Parkway<br>Mukilteo, WA 98275<br>425-349-3500 |                                    |
| TITLE  | SCHEMATIC, MODEL 48J SERIES LASERS |
| SIZE   | DOCUMENT NUMBER 810-17609-00       |
| REV  | R1                                 |
| DATE:  | August 20, 1998                    |
|  | SHEET 1 of 1                       |

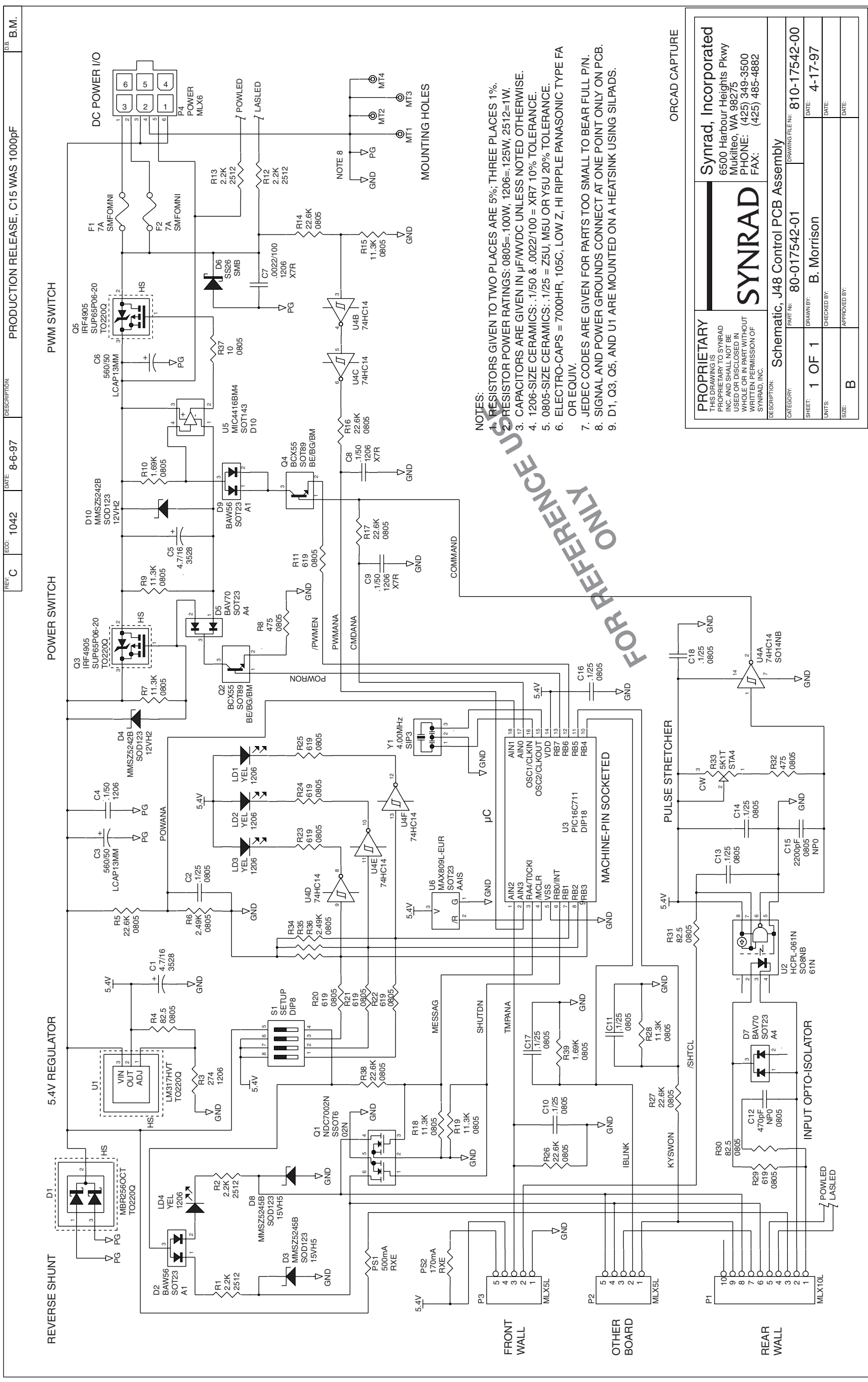

**SYNRAD**

**Synrad, Incorporated**  
 6500 Harbour Heights Pkwy  
 Mukilteo, WA 98275  
 PHONE: (425) 349-3500  
 FAX: (425) 485-4882

|  |  |                                   |
|--|--|-----------------------------------|
| PROPRIETARY<br>THIS DRAWING IS<br>PROPERTY OF SYNRAD<br>INC. AND SHALL NOT BE<br>USED OR DISCLOSED IN<br>WHOLE OR IN PART WITHOUT<br>THE WRITTEN PERMISSION OF<br>SYNRAD, INC. | DESCRIPTION:<br><b>Schematic, J48 Control PCB Assembly</b> | DRAWING FILE NO.:<br>810-17542-00 |
| CATEGORY:<br><b>1 OF 1</b>   | PART NO.:<br>80-017542-01                                  | DATE:<br>4-17-97                  |
| SHEET:<br><b>1 OF 1</b>  | DRAWN BY:<br>B. Morrison                                   | DATE:                             |
| UNITS:<br><b>B</b>   | CHECKED BY:  | DATE:                             |
| SIZE:  | APPROVED BY:   | DATE:                             |



**Appendix B**  
**UC-1000 Universal Laser Controller**

## Appendix B UC-1000 Laser Controller

### UC-1000 Laser Controller

The UC-1000 is designed to serve as a general-purpose interface between user signals and SYNRAD's complete line of CO<sub>2</sub> lasers. For additional information, consult the UC-1000 manual.

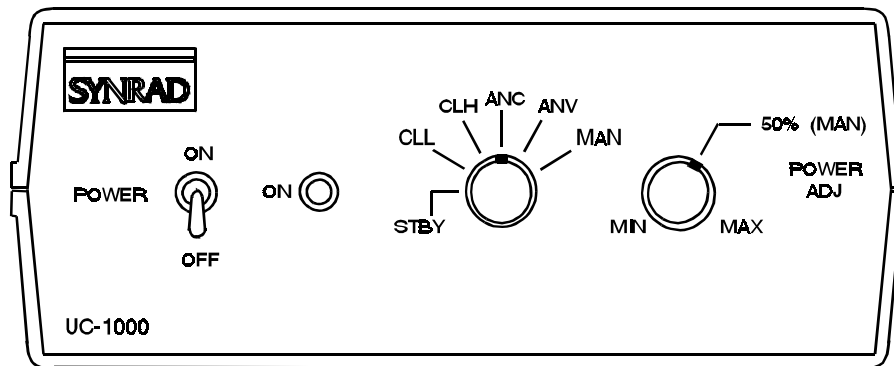

Front Panel

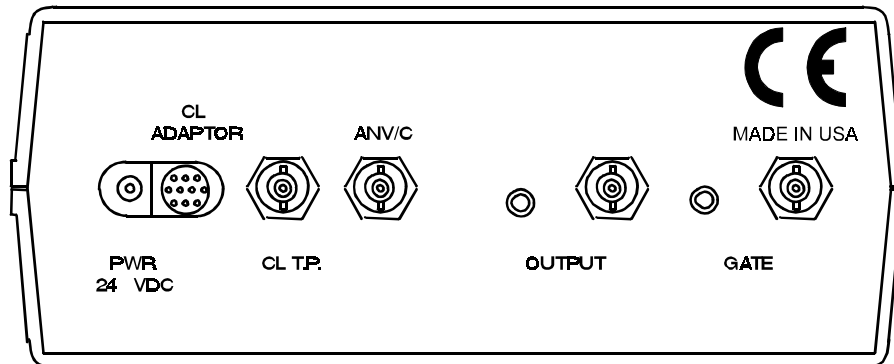

Rear Panel

### UC-1000 Power Controller

#### UC-1000 Operating Modes

UC-1000 operating modes are selected by means of a front panel, six-position rotary switch. The operating modes are as follows:

**Standby (STBY):** In this mode, only the 1  $\mu$ sec wide tickle pulse is generated. This tickle signal causes the laser plasma to be ionized without resulting in beam emission, providing quick response to user signals.



Closed Loop Low Gain (CLL): Closed loop operation of the laser can provide better than  $\pm 2\%$  power stability. This is achieved by splitting a portion of the outgoing laser power to a thermo-pile detector. The amplified signal is compared against a reference and regulates the output duty cycle (pulse width). The front panel POWER ADJ knob establishes the reference level. Operation in the closed loop mode requires a factory installed 48-CL laser-mounted power sensor.

Closed Loop High Gain (CLH): Same as CLL but with higher internal gain.

Remote Current Control (ANC): In this mode, an analog 4–20 mA current is applied to the UC-1000's ANV/C input connector. Laser power is zero at 4mA and maximum at 20mA. The 4–20 mA current loop is the standard industrial control interface for allowing loop supervision. Circuit input impedance is low.

Remote Voltage Control (ANV): In this mode, a 0–10 VDC analog voltage signal controls laser output. The laser's output power is zero at 0V and maximum at 10V. Circuit input impedance is high.

Manual (MAN): Laser power control is accomplished manually using the UC-1000's POWER ADJ knob.

### **Gate Function**

The GATE input connector (BNC or subminiature phono jack) provides an input for a TTL-level signal to cycle the beam on and off in response to an external pulse train. The gate function can be used in all five active modes. Front panel operating controls or remote inputs set the laser power level.

**On the standard UC-1000, the gate input is set to internal pull-up (normally on) mode. A logic high input signal or an open (disconnected) GATE input connector will cause the beam to turn on.** To gate the beam off, a logic low input or short circuit must be applied to the GATE input connector. UC-1000X (Mod-X) controllers have the gate input set to internal pull-down (normally off) mode. This prevents the beam from being enabled unless a logic high (+2.5 to 5V) signal is applied to the GATE input connector. The pull-down (normally off) mode ensures the laser beam is always off in the event the gate signal is open or disconnected, short circuited to ground, or if an asserted logic low state exists while the UC-1000 is powered up. If your application changes, you can reconfigure from one version to the other by changing a switch setting inside the controller. Consult the UC-1000 manual for detailed information.